

DEPARTMENT OF THE ARMY TECHNICAL MANUAL

OPERATOR'S AND ORGANIZATIONAL
MAINTENANCE MANUAL
GENERATOR SET, DIESEL ENGINE: 200 KW, 60 CYCLE, AC,
120/208V, 240/416V, 3 PHASE. CONVERTIBLE FO 167 KW,
50 CYCLE 120/208V, 240/416V, 3 PHASE,
MULTI-PURPOSE, PORTABLE, SKID MOUNTED. (MILITARY
DESIGN MODEL SF-200-MD/CIED) FSN 6115-999-7901

This copy is a reprint which includes current
pages from Changes 1 through 3.

HEADQUARTERS, DEPARTMENT OF THE ARMY
JANUARY 1968

SAFETY PRECAUTIONS

BEFORE OPERATION

Do not operate the generator set in an enclosed area unless the exhaust gases are piped to the outside. Inhalation of exhaust fumes may result in serious illness or death.

Do not smoke or use an open flame in the vicinity when servicing the batteries. Batteries generate hydrogen, a highly explosive gas. When removing batteries, remove both negative "ground" cables before removing positive cables.

Do not operate the generator set unless the ground terminal stud has been connected to a suitable ground. Electrical faults in the generator set, load lines, or load equipment can cause death by electrocution from contact with an ungrounded system.

When filling the fuel tank, always provide metal-to-metal contact between the container and the fuel tank. This will prevent a spark from being generated as fuel flows over the metallic surface.

Do not use a lifting device with a capacity of less than 12,000 pounds.

Do not allow the crated generator set to swing while it is suspended. Failure to observe this warning may result in serious injury or death to personnel.

Before making connections for parallel operation, be sure the generator sets are not operating and that all switches are off. Electrical faults in the generator set, load lines, and load equipment can cause death by electrocution from contact with an ungrounded system.

DURING OPERATION

Do not attempt to change a load connection or perform maintenance on the generator set while it is in operation. Always be sure it is not connected to an energized line before performing maintenance. The voltage generated by this equipment can cause death by electrocution.

AFTER OPERATION

Do not smoke or use an open flame in the vicinity when servicing the batteries. Batteries generate hydrogen, a highly explosive gas.

Do not use a lifting device with a capacity of less than 12,000 pounds. Do not allow the crated generator set to swing while it is suspended. Failure to observe this warning may result in serious injury or death to personnel.

Change In force: C1, C2, and C3

CHANGE

No. 3

HEADQUARTERS
DEPARTMENT OF THE ARMY
WASHINGTON, DC, 6 January 1975

**Operator's and Organizational Maintenance Manual
GENERATOR SET, DIESEL ENGINE:
200 KW, 60 HERTZ, AC, 120/208V, 240/416V, 3 PHASE;
CONVERTIBLE TO 167 KW, 50 HERTZ, 120/208V, 240/416V,
3 PHASE, MULTI-PURPOSE, PORTABLE, SKID MOUNTED.
(MILITARY DESIGN MODEL SF-200/MD/CIED) FSN 6115 00 7901**

TM 5-611540012, 12 January 1968, is changed as follows:

The title is changed to read as shown above.

Inside Front Cover. Add the following warnings.

BEFORE OPERATION

WARNING

Do not rely on grounding or safety devices to prevent accidents. Electrical circuits and equipment are potentially hazardous. Personnel should always exercise caution to prevent injury or possible death due to electrical shock.

DURING OPERATION

WARNING

Operation of this equipment presents a noise hazard to personnel in the area. The noise level exceeds the allowable limits for unprotected personnel. Wear ear muffs or ear plugs which were fitted by a trained professional.

AFTER OPERATION

WARNING

Dry cleaning solvent, Fed. Spec. P-D-680, used to clean parts is potentially dangerous to personnel and property. Do not use near

open flame or excessive heat. Flash point of solvent is 100°F (38°C) to 138°F (59°C).

Page 1-1. Paragraph 1-1c is superseded as follows:

c. You can improve this manual by recommending improvements using DA Form 2028 (Recommended Changes to Publications and Blank Forms) and mailing the form to Commander, US Army Troop Support Command, ATTN: AMSTS-MPP, 4300 Goodfellow Boulevard, St. Louis, MO 63120.

Page A-1. Paragraph A-1 is superseded as follows:

A-1. Fire Protection and Safety

TB 5-4200-200-10	Hand Portable Fire Extinguishers Approved for Army Users.
TB 5-4200-201-10	Hand Portable Fire Extinguishers for Rail, Marine, Amphibious, and Off-Road Equipment
TB MED 25	Noise and Conservation of Hearing

By Order of the Secretary of the Army:

FRED C. WEYAND
General, United States Army
Chief of Staff

Official:

VERNE L. BOWERS
Major General, United States Army
The Adjutant General

Distribution:

To be distributed in accordance with DA Form 12-25D, (qty rqr block No. 1089) Operator's Maintenance Requirements for Generator Sets, Engine Driven: 200 KW, 60 HZ, Precise Power.

Changes in force: C 1 and C 2

CHANGE

NO. 2

HEADQUARTERS
DEPARTMENT OF THE ARMY
WASHINGTON, D.C., 22 November 1974

**Operator's and Organizational Maintenance Manual
GENERATOR SET, DIESEL ENGINE: 200 KW, 60-
CYCLE, AC, 120/208V, 240/416V, 3-PHASE
CONVERTIBLE TO 167 KW, 50-CYCLE,
120/208V, 240/416V, 3-PHASE,
MULTI-PURPOSE, PORTABLE:
SKID MOUNTED
(MILITARY DESIGN MODEL SF-200-MD/CIED)
FSN 6115-999-7901**

TM 5-6115-400-12, 12 January 1968, is changed as follows:

Inside Front Cover. Add a safety precaution under the "DURING OPERATION" paragraph as follows:

Operation of this equipment presents a noise hazard to personnel in the area. The noise level exceeds the allowable limits for unprotected personnel. Wear ear muffs or ear plugs which were fitted by a trained professional.

Add a safety precaution under the AFTER OPERATION paragraph as follows:

By Order of the Secretary of the Army:

Official:

VERNE L. BOWERS
*Major General, United States Army
The Adjutant General*

Do not use dry cleaning solvent, PD 680 near open flame or excessive heat. The flash point of solvent is 100° F. 138° F. This solvent is used to clean parts and is potentially dangerous to personnel and property. *Page A-1.* Paragraph A-1 is superseded as follows:

A-1. Fire Protection and Safety.

TB 5-4200-200-10

Hand Portable Fire
Extinguishers
Approved for Army
Users.

TB MED 251

Noise and Conservation
of Hearing.

FRED C. WEYAND
*General, United States Army
Chief of Staff*

Distribution:

To be distributed in accordance with DA Form 12-25D, (qty rqr block No. 1089) Operator's Maintenance Requirements for Generator Sets, Engine Driven: 200 KW, 60 HZ, Precise Power.

CHANGE

No. 1

HEADQUARTERS
DEPARTMENT OF THE ARMY
WASHINGTON, D. C., 2 August 1969

**Operator and Organizational Maintenance Manual
GENERATOR SET, DIESEL ENGINE;
200 KW, 60 CYCLE, AC, 120/208V, 240/416V,
3 PHASE; CONVERTIBLE TO 167 KW, 50 CYCLE, 120/208V,
240/416V, 3 PHASE; MULTI-PURPOSE; PORTABLE; SKID MOUNTED
(MILITARY DESIGN MODEL SF 200-MD/CIED)
FSN 6115-999-7901**

TM 5-6115-400-12, 12 January 1968, is changed as follows:

Page 1-1. Paragraph 1-1c is superseded as follows:

c. Report all errors, omissions and recommendations for improving this publication by the individual user is encouraged. Report should be

submitted on DA Form 2028, Recommended Changes to DA Publications, and forwarded direct to Commanding General, U. S. Army Mobility Equipment Command, ATTN: AMSME-MPP, 4300 Goodfellow Boulevard, St. Louis, Mo. 63120.

**APPENDIX B
BASIC ISSUE ITEMS LIST**

Section I. INTRODUCTION

B-1. Scope

This appendix lists items which accompany the generator set or are required for installation, operation, or operator's maintenance.

B-2. General

This Basic Issue Items List is divided into the following sections:

a. *Basic Issue Items Section II.* A list of items which accompany the generator set and are required by the operator/crew for installation, operation, or maintenance.

b. *Maintenance and Operating Supplies Section III.* A listing of maintenance and operating supplies required for initial operation.

B-3. Explanation of Columns

The following provides an explanation of columns in the tabular list of Basic Issue Items, section II.

a. *Source Maintenance and Recoverability Codes (SMR).*

(1) Source code, indicates the selection status and source for the listed item. Source codes are:

<i>Code</i>	<i>Explanation</i>
	Repair parts which are stocked in or supplied from the P GSA/DSA, or Army supply system and authorized for use at indicated maintenance categories.

<i>Code</i>	<i>Explanation</i>
P2	Repair parts which are procured and stocked for insurance purposes because the combat or military essentiality of the end item dictates that a minimum quantity be available in the supply system.
M	Repair parts which are not procured or stocked, but are to be manufactured in indicated maintenance levels.
A	Assemblies which are not procured or stocked as such, but are made up of two or more units. Such component units carry individual stock numbers and descriptions, are procured and stocked separately and can be assembled to form the required assembly at indicated maintenance categories.
X	Parts and assemblies which are not procured or stocked and the mortality of which normally is below that of the applicable end item or component. The failure of such part or assembly should result in retirement of the end item from the supply system.
X1	Repair parts which are not procured or stocked. The requirement of such items will be filled by use of the next higher assembly or component.
X2	Repair parts which are not stocked. The indicated maintenance category requiring such repair parts will attempt to obtain them through cannibalization. Where such repair parts are not obtainable through cannibalization, requirements will be requisitioned, with accompanying justification, through normal supply channels.

Code **Explanation**
G Major assemblies that are procured with PEMA funds for initial issue only as exchange assemblies at DSU and GSU level. These assemblies will not be stocked above GS and DS level or returned to depot supply levels.

(2) Maintenance code, indicates the lowest category of maintenance authorized to install the listed item. The maintenance level code is:

Code **Explanation**
C Operator/crew

(3) Recoverability code, indicates whether unserviceable items should be returned for recovery or salvage. Items not coded are expendable. Recoverability codes are:

R Repair parts and assemblies which are economically repairable at DSU and GSU activities and are normally furnished by supply on an exchange basis.

S Repair parts and assemblies which are economically repairable at DSU and GSU activities and which normally are furnished by supply on an exchange basis. When items are determined by a GSU to be uneconomically repairable they will be evacuated to a depot for evaluation and analysis before final disposition.

T High dollar value recoverable repair parts which are subject to special handling and are issued on an exchange basis. Such repair parts are normally repaired or overhauled at depot maintenance activities.

U Repair parts specifically selected for salvage by reclamation units because of precious metal content, critical materials, or high dollar value reusable casings or castings.

b. Federal Stock Number. This column indicates the Federal stock number assigned to the item and will be used for requisitioning purposes.

c. Description. This column indicates the Federal item name and any additional description of the item required.

d. Unit of Measure (U/M). A two-character alphabetic abbreviation indicating the amount or quantity of the item upon which the allowances are based, e.g., ft, ea, pr, etc.

e. Quality Incorporated in Unit. This column indicates the quantity of the item used in the assembly group. A "V" appearing in this column in lieu of a quantity indicates that a definite quantity cannot be indicated (e.g., shims, spacers, etc.).

f. Quantity Furnished With Equipment. This column indicates the quantity of an item furnished with the equipment.

g. Illustration. This column is not applicable.

4. Explanation of Columns in the Tabular List of Maintenance and Operating Supplies Section III.

a. Component Application. This column identifies the component application of each maintenance or operating supply item.

b. Federal Stock Number. This column indicates the Federal stock number assigned to the item and will be used for requisitioning purposes.

c. Description. This column indicates the item name and brief description.

d. Quantity Required for Initial Operation. This column indicates the quantity of each maintenance or operating supply item required for initial operation of the equipment.

e. Quantity Required for 8 Hours Operation. This column indicates the estimated quantities required for an average 8 hours of operation.

f. Notes. This column indicates informative notes keyed to data appearing in a preceding column.

Section II. BASIC ISSUE ITEMS

(1) SMR CODE	(2) FEDERAL STOCK NUMBER	(3) DESCRIPTION	(4) UNIT OF MEAS	(5) QTY INC IN UNIT	(6) QTY FURN WITH EQUIP	(7) ILLUSTRATION	
						(a) FIGURE NO.	(b) ITEM NO.
PC PC	7510-889-3494 7520-559-9618	Binder, Log Case, Manual DA Lubrication Chart LO 5-6115-400-12 DA Technical Manual TM 5-6115-400-12 DA Technical Manual TM 5-6115-480-12 BASIC ISSUE ITEMS, TROOP INSTALLED	EA EA EA EA EA		1 1 1 1 1		
PC PC PC PC	2910-066-1235 5935-258-9156 4210-288-8269 5975-878-3791	Adapter, Drum Connector, Plug Extinguisher, Fire Rod, Ground Assembly	EA EA EA EA				

Section III. MAINTENANCE AND OPERATING SUPPLIES

(1) Component application	(2) Federal Stock No.	(3) Description	(4) Quantity required f/initial operation	(5) Quantity required f/8 hr operation	(6) Notes
CRANKCASE	9150-680-1104(2) 9150-680-1105(2) 9150-242-7605(2)	OIL, LUBRICATING: 55 gal drum as follows: HDO 30 HDO 10 OES	44 qts(l) 44 qts(1) 44 qts(1)	(3) (3) (3)	(1) Includes quantity of oil to fill engine oil system as follows: 38 qt Crankcase 6 qt Filters (2) See C9100-IL for additional data and requisitioning procedures. (3) See current LO for grade application and replenishment intervals,
FUEL TANK	9140-286-5297(2) 9140-286-5289(2) 9140-286-5285(2)	FUEL, DIESEL: 55 gal drum as follows: DF2 DF1 DFA	200 gal 200 gal 200 gal	127 gal 127 gal 127 gal	(3) See current LO for grade application and replenishment intervals,
GOVERNOR	9150-223-4134(2)	OIL, HYDRAULIC: 1 gal can as follows: OHA	8qts	(3)	
RADIATOR	6850-244-8730 6850-174-1806	WATER ANTIFREEZE: 5 gal can as follows: Ethylene Glycol ANTIFREEZE: 55 gal drum as follows: Arctic Grade	70qts 42 qts 70 qts		

By Order of the Secretary of the Army:

Official:

KENNETH G. WICKHAM,
*Major General, United States Army,
The Adjutant General*

W. C. WESTMORELAND,
*General, United States Army
Chief of Staff*

Distribution:

To be distributed in accordance with DA Form 12-25, Section IV, (qty rqr block no, 754) organizational maintenance requirements for Generator Sets, Engine Driven, 150 KW and Up.

Operator's and Organizational Maintenance Manual

**GENERATOR SET, DIESEL ENGINE: 200 KW, 60
CYCLE, AC, 120/208V, 240/416V, 3 PHASE
CONVERTIBLE TO 167 KW, 50 CYCLE, 120/208V,
240/416V, 3 PHASE, MULTI-PURPOSE, PORTABLE:
SKID MOUNTED
(MILITARY DESIGN MODEL SF-200-MD/CIED)
FSN 6115-999 7901**

		Paragraph	Page
CHAPTER 1.	INTRODUCTION		
Section I.	General	1-1, 1-2	1-1
II.	Description and data	1-3 - 1-5	1-1 - 1-6
CHAPTER 2.	INSTALLATION AND OPERATING INSTRUCTIONS		
Section I.	Service upon receipt of equipment.....	2-1 - 2-6	2-1 - 2-4
II.	Movement to a new worksite.....	2-7, 2-8	2-5
III.	Controls and instruments	2-9, 2-10	2-6
IV.	Operation of generator set	2-11 - 2-14	2-11
V.	Operation under unusual conditions.....	2-15 - 2-20	2-16 - 2-18
VI.	Operation of auxiliary materiel used in conjunction with the generator set.....	2-21 - 23	2-18
CHAPTER 3.	OPERATOR'S AND ORGANIZATIONAL MAINTENANCE INSTRUCTIONS		
Section I.	Operator and organizational maintenance tools and equipment.....	3-1, 3-2	3-1
II.	Lubrication.....	3-3, 3-4	3-1
III.	Preventive maintenance checks and services.....	3-5, 3-6	3-5
IV.	Operator's maintenance.....	3-7 - 3-14	3-6 - 3-8
V.	Troubleshooting.....	3-15, 3-16	3-12
VI.	Radio interference suppression.....	3-17 - 3-21	3-16 - 3-17
VII.	Engine valve mechanism.....	3-22, 3-23	3-18
VIII.	Engine lubrication system	3-24 - 3-28	3-21 - 3-22
IX.	Fuel system	3-29 - 3-41	3-24 - 3-36
X.	Engine cooling system	3-42 - 3-51	3-42 - 3-48
XI.	Turbocharger and manifolds	3-52 - 3-55	3-49 - 3-53
XII.	Engine electrical system	3-56 - 3-62	3-54 - 3-58
XIII.	Engine controls and instruments	3-63 - 3-66	3-58
XIV.	Generator controls and instruments	3-67 - 3-78	3-60 - 3-61
XV.	Frame and housing.....	3-79, 3-80	3-62
XVI.	Generator	3-81, 3-82	3-63
XVII.	Winterization equipment	3-83, 3-84	3-64
CHAPTER 4.	SHIPMENT AND LIMITED STORAGE AND DEMOLITION TO PREVENT ENEMY USE		
Section I.	Shipment and limited storage	4-1 - 4-4	4-1 - 4-2
II.	Demolition of materiel to prevent energy use.....	4-5 - 4-9	4-2
APPENDIX A.	REFERENCES		A-1
B.	BASIC ISSUE ITEMS LIST.....		B-1
C.	MAINTENANCE ALLOCATION CHART		C-1
INDEX		I-1

CHAPTER 1 INTRODUCTION

Section I. GENERAL

1-1. Scope

a. These instructions are published for the use of the personnel to whom the Military Standard Model SF-200-MD/CIED (Allis-Chalmers Model 25000-4444650) generator set is issued. They provide information on the operation and organizational maintenance of the equipment. Also included are descriptions of main units and their functions in relationship to other components.

b. Appendix A contains a list of publications applicable to this manual. Appendix B contains a list of basic issue items authorized the operator of this equipment and the list of maintenance and operating supplies required for initial operation. Appendix C contains the Maintenance allocation chart.

c. DA Form 2028 (Recommended Changes to DA Publications) will be used for reporting discrepancies and recommendations for improving this equipment publication. This form will be filled out by the individual using the manual and forwarded direct to Commanding

General, U. S. Army Mobility Equipment Command, ATTN: AMSME-MP, 4300 Goodfellow Blvd., St. Louis, Mo., 63120.

d. Report all equipment improvement recommendations as prescribed by TM 38-750.

1-2. Record and Report Forms

a. DA Form 2258 (Depreservation Guide of Engineer Equipment).

b. For other record and report forms applicable to operator, crew and organizational maintenance, refer to TM 38-750.

Note. Applicable forms, excluding Standard Form 46, (United States Government Motor Vehicles Operator's Identification Card) which is carried by the operator, will be kept in a canvas bag mounted on the equipment.

Section II. DESCRIPTION AND DATA

1-3. Description

a. *General.* The Military Standard Model SF-200-MD/CIED (Allis-Chalmers Model 25000-4444650) generator set (figs. 1 and 2) is a multi-purpose, portable, skid-mounted, self-contained unit. Each set is equipped with an engine oil pan heating element and other connections for field installation of winterization equipment. The generator set is provided with the controls, instruments, and accessories necessary for operation as a single unit and for operation in parallel with other generator sets. It can be connected to deliver 3 phase, 4 wire, 240 volts line-to-neutral and 416 volts line-to-line (240/416 volts) or 3 phase, 4 wire, 120 volts

line-to-neutral and 208 volts line-to-line (120/208 volts). Engine speed is regulated by an electric governing system.

b. *Engine.* The Allis-Chalmers Model 25,000 engine is a liquid cooled, 6 cylinder, valve-in-head, 4 stroke cycle, turbocharged and intercooled, full diesel engine.

c. *Generator.* The Electric Machinery Model 651853 alternating current generator is a fully enclosed, fan-cooled, revolving field, 3phase alternator. The generator rotor is driven directly by the engine flywheel through a flexible coupling. When driven at its rated speed of 1,800 rpm, the generator will produce 200 KW (kilowatt) at 60 cycles with a

power factor of 0.8 and it will deliver 694 amperes at 120/208 volts or 347 amperes at 240/416 volts. When driven at 1,500 rpm, the generator will produce 167 KW at 50 cycles with a power factor of 0.8 and it will deliver 580 amperes at 120/208 volts or 290 amperes at 240/416 volts.

1-4. Identification and Tabulated Data

a. *Identification.* The generator set has two major identification plates. The information contained on these plates is listed below.

(1) *Engine.*

Manufacturer.....Allis-Chalmers
 Model.....25000
 Part number4388490

(2) *Generator.*

Manufacturer.....Electric Machinery Mfg.
 Co.
 Part number65-1853-33
 Type.....Synchronous Rotating
 Field

Frame723
 60 Cycle Ratings
 KVA250
 RPM100
 Volts120/208, 240/416
 Amperes694/347

59 Cycle Ratings
 KVA209
 RPM1500
 Volts120/208, 240/416
 Amperes580/290

b. *Tabulated Data.*

(1) *Generator Set.*

Military standard modelSF-200-MD/CIED
 Manufacturer.....Allis-Chalmers
 Manufacturer model25000-4444650

(2) *Engine.*

Manufacturer.....Allis-Chalmers
 Model.....25000
 Type.....Diesel 4-stroke cycle
 with turbocharger and
 intercooler

Number of cylinders6
 Bore.....5-1/4 in.
 Stroke6-1/2 in.
 Crankshaft rotation.....Clockwise
 (viewed from fan end).
 Number of main bearings.....7
 Piston displacement.....844 cu. in.
 Rated horsepower348 at 1,800 rpm

(3) *Fuel Injection Pump.*

Manufacturer.....American Bosch.
 TypeMultiple-Plunger
 Part no.APE-6BB-120Q-574iA1
 Governor part no.....GVB-275/900C746A
 Inner Spring2 mm gap
 Outer Spring-1 mm. precompressed
 Torque Cam.....1/2 in.
 Torque Cam Angle.....90°

(4) *Air Cleaner.*

Manufacturer.....Farr
 Element Part Number.....C-12233-
 Type.....Dry replaceable
 element

(5) *Electric Governor.*

Manufacturer.....Westinghouse
 Model.....LEH

Components:

Electric Control Unit.....456A291G05
 Part Number.
 Load Measurement32D1580G06
 Unit-Part number.
 Electro-Hydraulic32 I11560G13
 Throttle Actuator-
 Part Number.

(6) *Starting Motor.*

Manufacturer.....Delco-Remy
 Part Number1113835
 Volts.....24

(7) *Generator (battery charging).*

Manufacturer.....Delco-Remy
 Part number110,599
 Military StandardMS13823-1
 Volts.....24

(8) *Generator Regulator (battery charging).*

Manufacturer.....Delco-Remy
 Part number118644
 Military StandardMS13805-1
 Volts.....24

(9) *Batteries.*

Military standard-MS3500
 Quantity4
 Volts.....12
 Connections.....Series-parallel for 24
 volts

(10) *Engine Oil Filter.*

Manufacturer.....Allis-chalmers
 Type.....Replaceable element (3)

(11) *Fuel Strainer.*

Manufacturer.....Allis-Chalmers
 Type.....Cleanable element

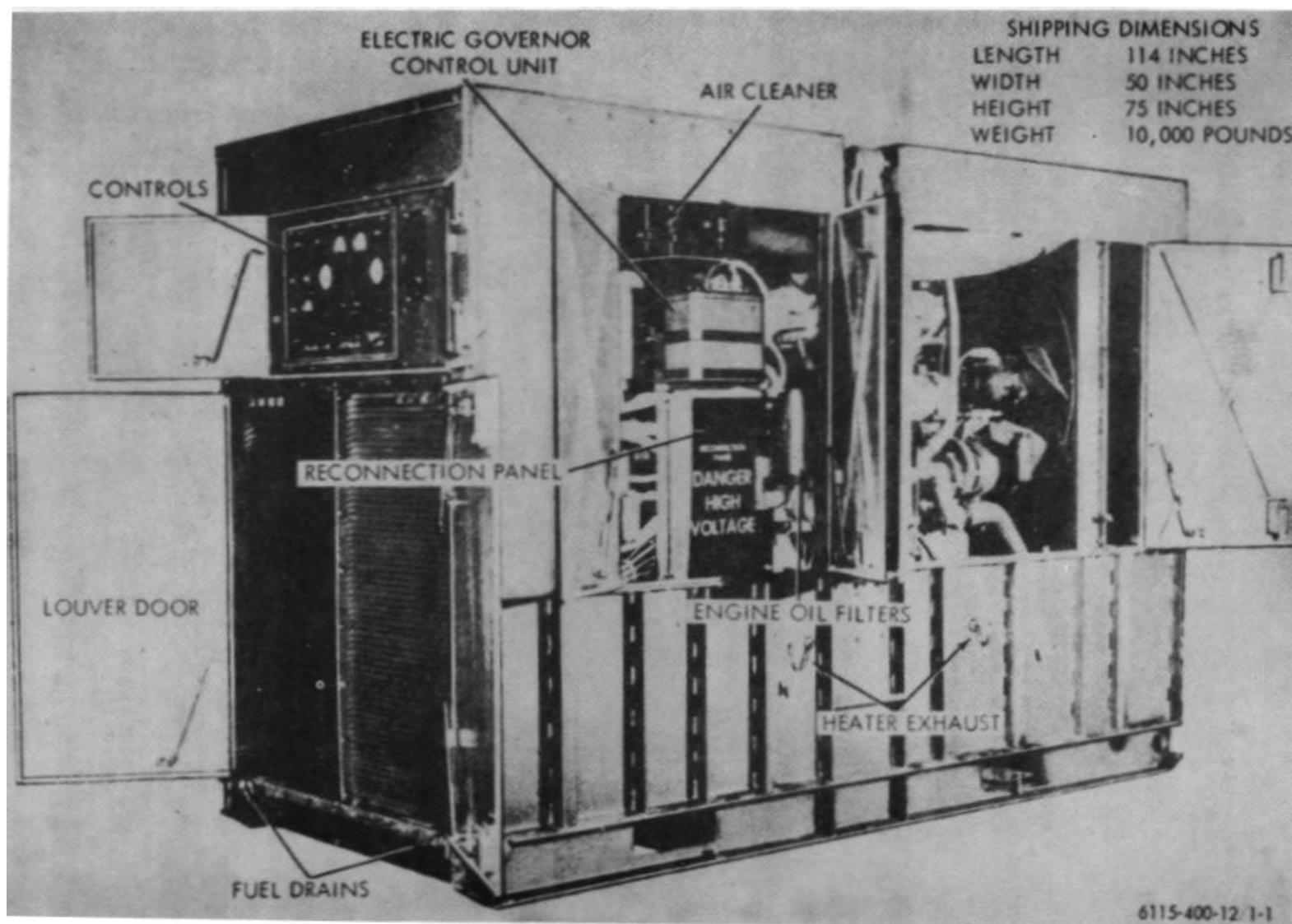

Figure 1-1. Generator set, right rear three-quarter view, with shipping dimensions

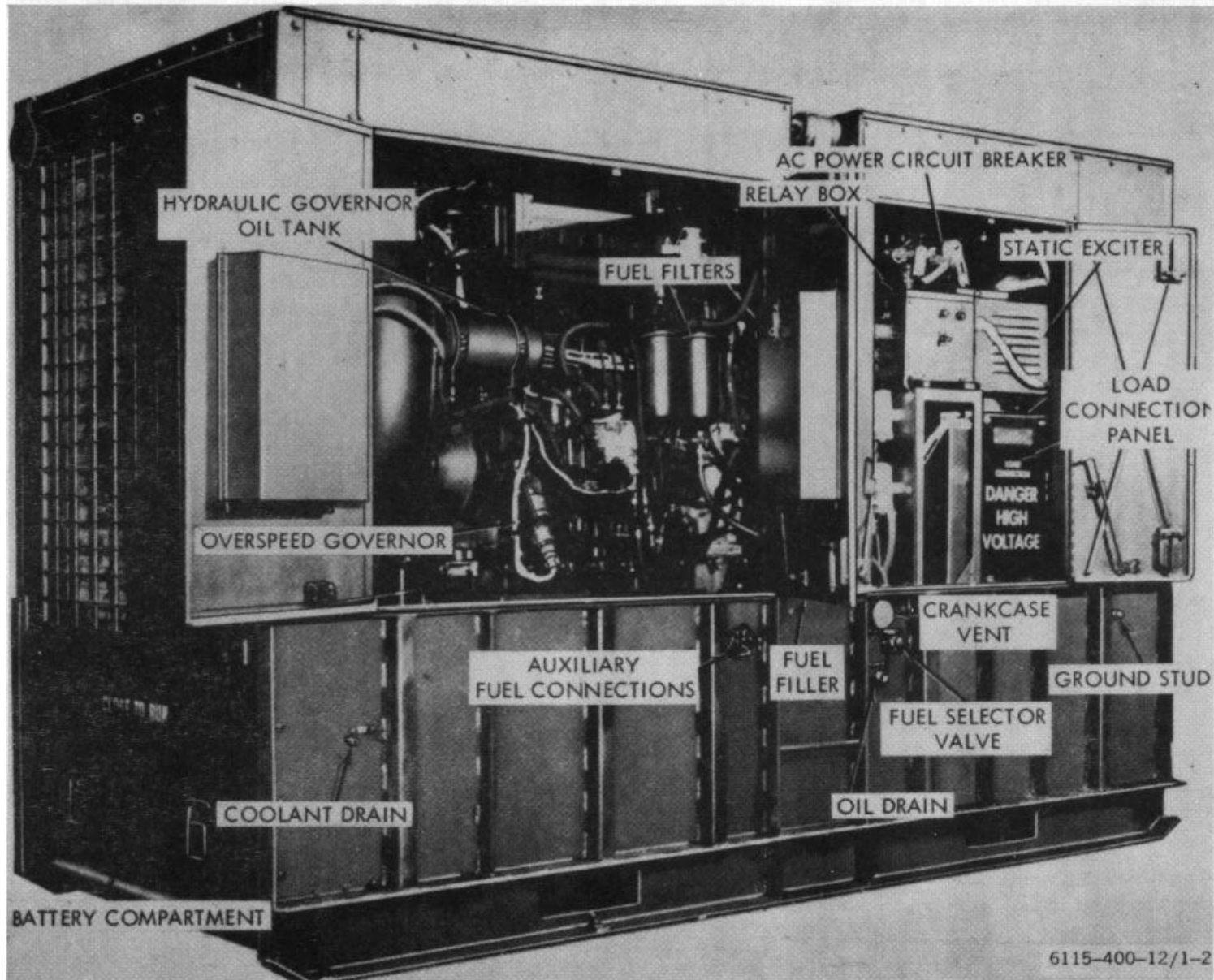

Figure 1-2. Generator set, left front three-quarter view.

6115-400-12/1-2

(12) *Fuel Filters.*

Manufacturer.....Allis-Chalmers
 Type.....Replaceable elements
 (2)

(13) *Fuel Transfer Pumps.*

Quantity4
 Manufacturer.....Bendix Corp.
 Part number480517
 Military standard.....MS131-2
 Volts.....24
 Ground polarityNegative

(14) *Heaters (optional equipment).*

Manufacturer.....Benmar
 Model.....CP3050
 Volts.....24
 FuelMulti

(15) *Adjustment Data.*

Engine intake valves.....0.015 in.
 (hot) .
 Engine exhaust valves.....0.020 in.
 (hot).

(16) *Governor System Specifications.*

Frequency regulation..... The governor is adjustable to maintain a frequency regulation within 1/4 of one percent of rated frequency.

Steady state performance At constant loads from no load to rated load, the governor will maintain frequency of plus or minus 1/4 of one percent of rated frequency.

Transient performance Following a sudden increase or decrease in load up to and including rated load, the governing system will reestablish stable engine operating conditions within one second. The maximum transient frequency change above or below the new steady state frequency will not exceed 1 1/2 percent of rated frequency.

(17) *AC Voltage Regulation System Specifications.*

Voltage regulation The ac voltage regulator will maintain voltage within one percent of rated voltage from no load to rated load and from rated load to no load.

Steady state performance At constant loads from no load to rated load, the voltage at the set terminals will not deviate more than 1/2 of 1 percent from its average mean square (rms) value.

Transient performance Performance of the set under transient conditions shall be as follows:

- (a) With the set initially operating at no load, rated voltage, and rated frequency (60 cycles), the rms terminal voltage of the set shall not drop to less than 70 percent of no load voltage, when a balanced 3phase, 0.4 pf (or less, lagging), static load having an impedance of 0.5 per unit is suddenly applied to the output terminals of the set. When connected to the specified load, the generator shall recover to a minimum of 95% rated voltage within 0.7 seconds and shall stabilize at or above this voltage. The above specified voltage dip shall not be exceeded when a fully-loaded induction motor of the above specified impedance is used in place of a static load, and no reactions shall be set up to prevent full acceleration of the motor with rated torque applied to its shaft.
- (b) When the set is initially operating at rated frequency and rated voltage and following any sudden change in load from no load to full load, the instantaneous rms voltage shall not drop to less than 85 percent of rated voltage for 60 cycle operation and shall reach stable conditions within 0.5 second; no overswing or undershoot of the final voltage may exceed the initial voltage transient in amplitude. The above requirements shall also apply when load is suddenly changed from full load to no load, except that the initial voltage transient shall involve a voltage rise instead of a dip.

- (18) *Capacities.*
 Fuel Tank.....200 gal
 Governor hydraulic.....2 gal.
 Engine lubricating11 gal.
 Cooling system70 qt

- Length.....114 in.
 Width50 in.
 Height75 in.
 Weight (dry-approx.)10,000 lbs.

Figure 1-3. Wiring diagram
 Located in back of manual

- (19) *Nut and Bolt Torque Data.*
 Fuel injection pump.....40-45 ft. lbs.
 coupling capscrew.
 Oil filter center bolt.....45-50 ft. lbs.
 Nozzle holder clamp nut.....21-24 ft. lbs
 Fuel injection line nut20-25 ft. lbs.
 Oil pressure regulating125-135 ft. lbs.
 Screw lock nut

1-5. Difference in Models

This manual covers only the Military Standard Model SF-200-MD/CIED (Allis-Chalmers Model 25000-4444650) generator set. No known unit differences exist for the model covered by this manual.

(20) *Dimensions and Weight.*

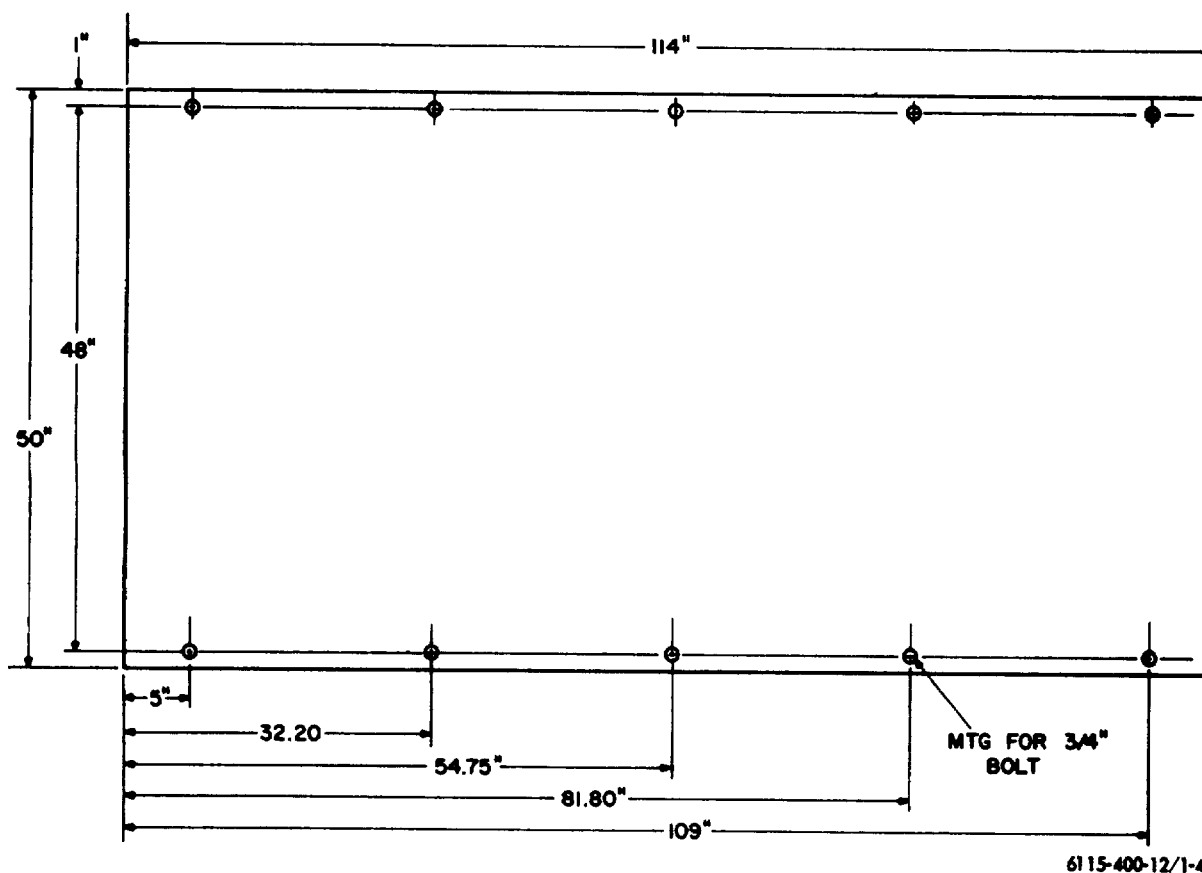

Figure 1-4. Base plan

**CHAPTER 2
INSTALLATION AND OPERATING INSTRUCTIONS**

Section I. SERVICE UPON RECEIPT OF EQUIPMENT

2-1. Unloading the Equipment The approximate total dry weight of the generator set is 10,000 pounds. A crane may be used to unload the unit. The equipment must be kept in the UP position while unloading.

Warning

Do not use a lifting device with a capacity of less than 12,000 pounds. Do not allow the crated generator set to swing while it is suspended. Failure to observe this warning may result in serious injury or death to personnel.

2-2. Unpacking the Equipment

a. General. For domestic shipment, the generator set is shipped uncrated on wooden skids.

b. Depreservation. Prior to placing the unit in operation, accomplish depreservation in accordance with instructions outlined in DA Form 2258 (Depreservation Guide of Engineer Equipment). DA Form 2258 is attached on or near the operator's controls.

2-3. Inspecting and Servicing Equipment

a. Inspection. Make a thorough visual inspection of the entire generator set for loose or missing mounting hardware, damage, and missing parts. Inspect the fuel lines for cracks and leaks.

b. Servicing.

- (1) Perform the preventive maintenance checks and services (para 3-6).
- (2) Lubricate the unit in accordance with the current lubrication order.
- (3) Service the batteries.
- (4) Refer to table 2-1 for anti-freeze solution percentages and to TM 9-207 for detailed cold weather operation instructions.

2-4. Installation of Separately Packed Components

Batteries. The four 12-volt batteries are located below the radiator. Batteries are shipped in dry state and the electrolyte is shipped in a separate container. Fill and connect batteries as described below. See figure 2-2.

Caution

Use extreme care when handling electrolyte. Wash immediately if skin has been exposed. Change clothing contaminated by electrolyte.

Table 2-1. Freezing Points, Composition and Specific Gravities of Military Antifreeze Materials

Lowest expected ambient temperature, °F.	Pints of inhibited glycol per gallon of coolant ¹	Compound, Antifreeze Arctic ²	Ethylene glycol coolant solution specific gravity at 68°F. ³
+20 ± 10 0	1-1/2 2 2-3/4	Issued full strength and ready mixed for 0° to -65°F. temperatures for both initial installation and replenishment of losses.	1.022 1.036 1.047

See footnote at end of table.

Table 2-1. Freezing Points, Composition and Specific Gravities of Military Antifreeze Materials-Continued

Lowest expected ambient temperature, °F.	Pints of inhibited glycol per gallon of coolant ¹	Compound, Antifreeze Arctic ²	Ethylene glycol coolant solution specific gravity at 68°F. ³
-10 -20 -30 -40 -50 -60 -75	3-1/4 3-1/2 4 4-1/4 Arctic Anti-freeze preferred	DO NOT DILUTE WITH WATER OR ANY OTHER SUBSTANCE	1.055 1.062 1.067 1.073

¹ Maximum protection is obtained at 60 percent by volume (4.8 pints of ethylene glycol per gallon of solution).

² Military Specifications MIL-C-11755 Arctic type, nonvolatile antifreeze compound is intended for use in the cooling system of liquid cooled internal combustion engines. It is used for protection against freezing primarily in Arctic regions where the ambient temperature remains for extended periods of time close to -40°F or below, to as low as -90°F.

³ Use an accurate hydrometer. To test hydrometer, use one part ethylene glycol type antifreeze to two parts water. This should produce a hydrometer reading of 0°F.

Note. Fasten a tag near the radiator filler cap indicating the type of antifreeze.

Caution

If ambient temperature is 70°F. or above, do not use antifreeze of any kind. If ambient temperature is between 40°F, and 70°F., the use of antifreeze is optional.

- a. Open access door and remove batteries.
- b. Remove cell caps and fill battery cells with electrolyte.
- c. Make sure vent holes in cell caps are open and install caps.
- d. Reinstall batteries.
- e. Positive and negative cables are disconnected from the batteries when generator set is shipped. Connect these cables as illustrated in figure 2-2.
- f. Tighten all post connectors securely to the posts.

2-5. Installation or Setting-Up Instructions

- a. *General.* The generator set should be installed on a level site, clear of obstacles, and with ample ventilation.
- b. *Installation.* When preparing for a permanent installation, be sure the base is solid enough to support the weight of the unit. Refer to figure 1-4 for dimensions of the base.

Select a site where there will be sufficient space on all sides for servicing and operation of the unit. When preparing for temporary installation, move the

generator set as close to the worksite as practical. Avoid, if possible, dusty or sandy locations. Use suitable 2-2 planks, logs, or other material for a base, in an area where the ground is soft.

c. *Indoor Installation.* Keep the area well ventilated at all times, so that the generator set will receive a maximum supply of air. Install a gas-tight exhaust line as large as the exhaust outlet to pipe the exhaust gases to the outside. Use as few bends in the line as possible. Provide metal shields for the exhaust lines where they pass through flammable walls. Wrap the exhaust lines with asbestos if there is any danger of anyone touching them.

Warning

Do not operate the generator set in an enclosed area unless the exhaust gases are piped to the outside. Inhalation of exhaust fumes will result in serious illness or death.

d. *Leveling.* The generator set is a portable unit and is designed to operate satisfactorily up to 150 out of level. Set up the unit as level as possible and keep it as level as possible during operation.

e. *Grounding.* The generator set must be grounded prior to operation. The ground can be, in order of preference, an underground metallic water piping system, a driven metal rod, or a buried metal plate. A ground rod must have a minimum diameter of 5/8 inch if solid or 3/4 inch if pipe, and driven to a minimum depth of eight feet. A ground plate must have a minimum area of nine square feet and be buried at a minimum depth of four feet. The ground lead must be at least No. 6

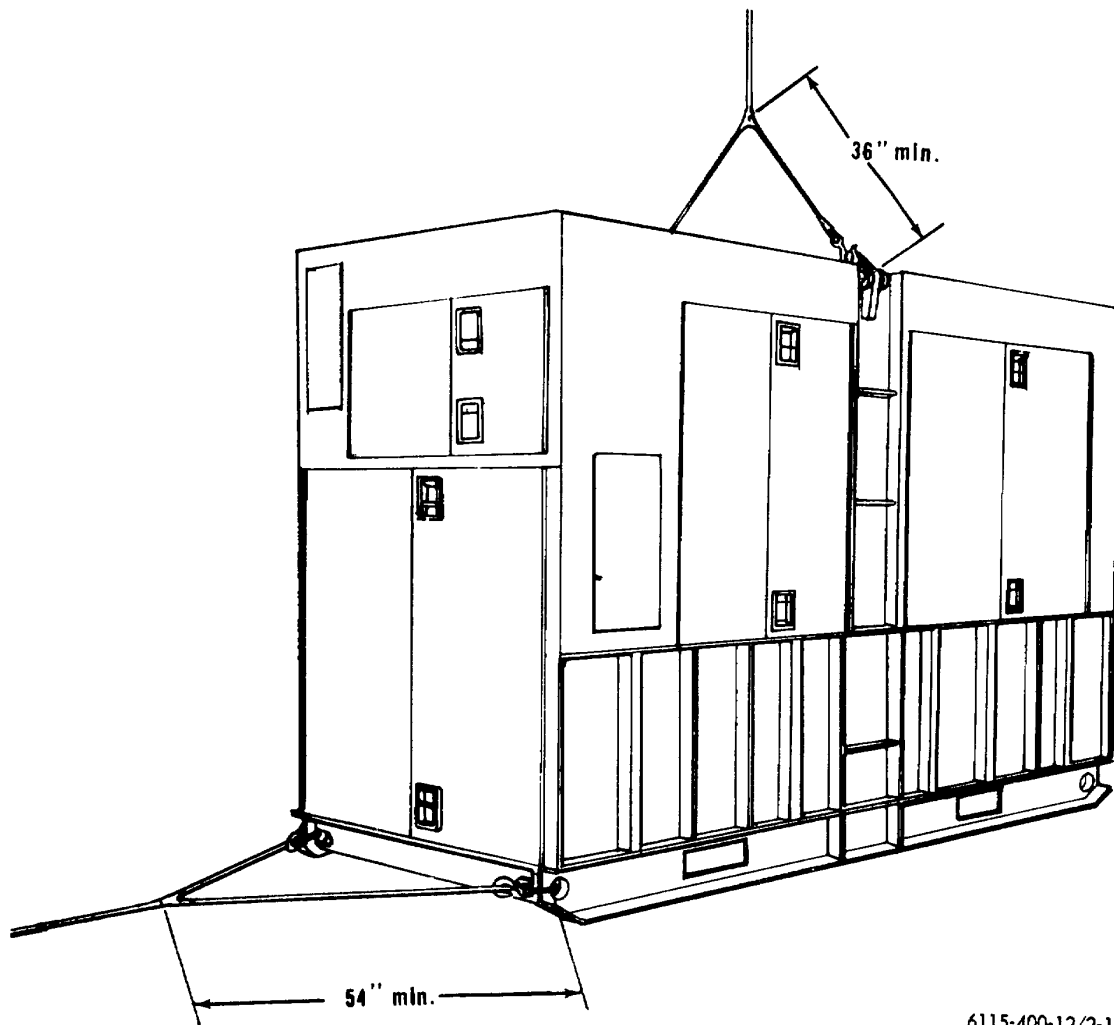

6115-400-12/2-1

Figure 2-1. Lifting and towing slings.

AWG (American Wire Gage) copper wire and be bolted or clamped to the rod, plate, or piping system. Connect the other end of the ground lead to the generator set ground terminal stud (fig. 1-2).

Warning

Do not operate the generator set unless the ground terminal stud has been connected to a suitable ground. Electrical faults in the generator set, load lines, or load equipment, can cause injury or electrocution from contact with an ungrounded system.

f. Load Connections. Refer to figure 2-3 and connect the load cable to the generator set.

Note. The load terminals will accommodate 2-wire, single phase, and 4-wire, 3-phase loads. One or more single-phase loads can be served alone in combination with 3-phase loads, but the load on any one phase must not exceed 25% of the current rating of the generator set.

g. Auxiliary Fuel Lines. If an auxiliary fuel source is to be used, be sure the auxiliary fuel 2-3

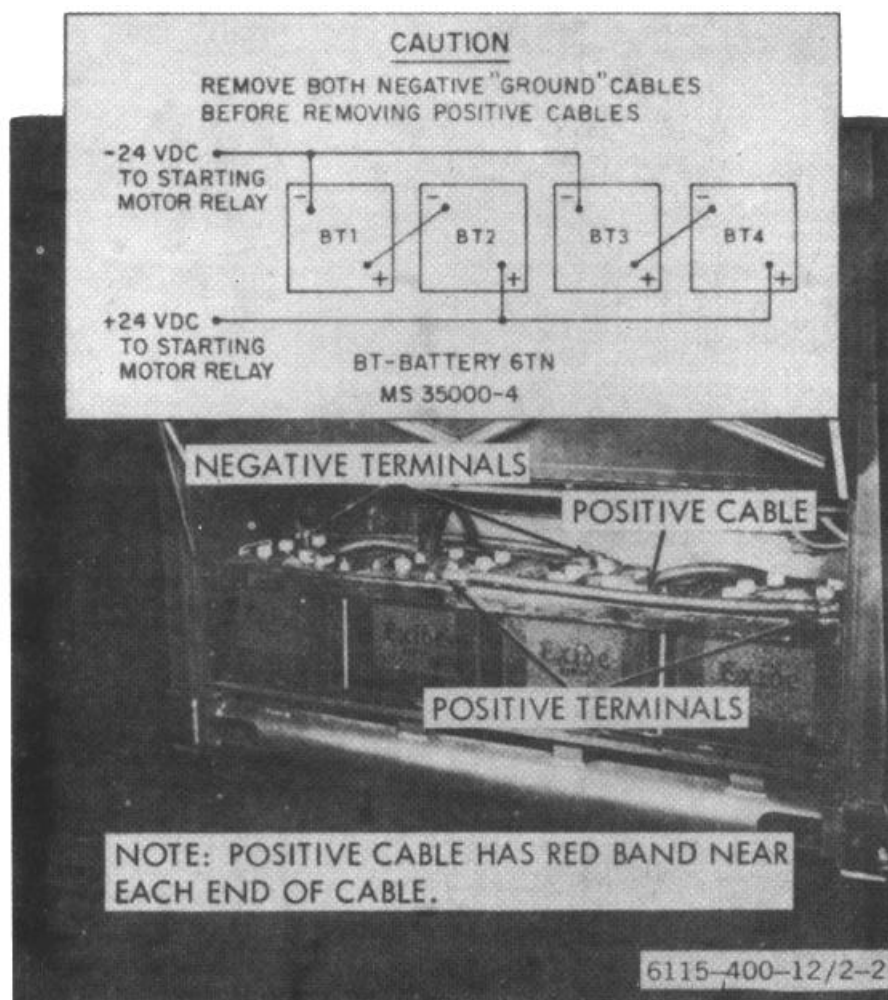

Figure 2-2. Batteries.

source is not more than 12 feet below the fuel pumps. Connect one end of the auxiliary fuel line to the external fuel source. Refer to figure 2-4 and connect the other end of the auxiliary fuel line to the auxiliary fuel connection of the generator set. Turn the fuel selector valve to the auxiliary position (para 2 10).

2-6. Equipment Conversion

Remove protective cover and refer to figure 2-5 for equipment conversion instructions.

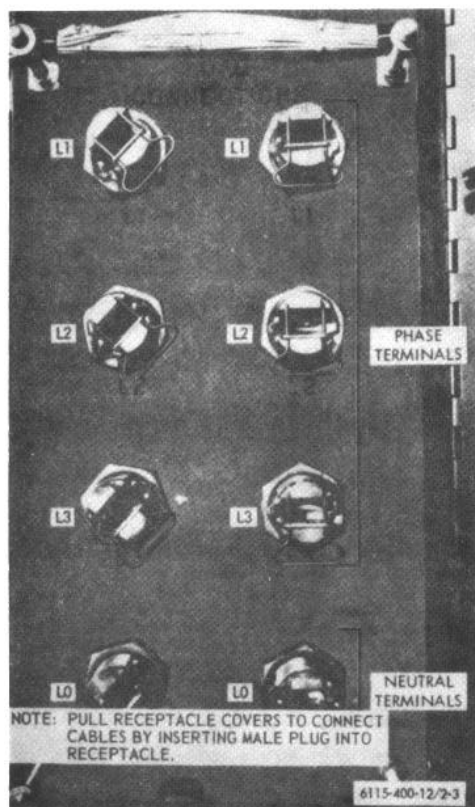

Figure 2-3. Lead cable connections.

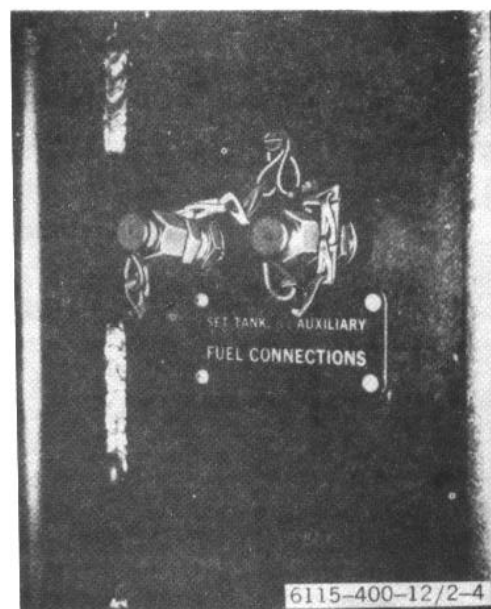

Figure 2-4. Auxiliary fuel connections.

Section II. MOVEMENT TO A NEW WORKSITE

2-7. Dismantling for Movement

a. Preparation for Movement.

- (1) Disconnect the load cables (fig. 23).
- (2) Remove the exhaust pipe extension if used.
- (3) D-rain the fuel tank (fig. 3-4).
- (4) Disconnect the batteries. See figure 2-2.
- (5) Refer to the Basic Issue Items List (app. B) and make sure that all items are on or with the equipment and properly stowed.
- (6) Disconnect the ground lead from the ground terminal stud (para 2-5).

- (7) Disconnect any of the external hoses, lines, and cables, if used.
- (8) Close and secure all doors and panels.

b. Movement. If the generator set is to be moved only a short distance and the terrain is suitable, attach a suitable towing device to the towing eyes of the unit and tow the generator set to the new worksite.

2-8. Reinstallation after Movement

Refer to paragraph 2-5 for reinstallation instructions after movement to a new worksite.

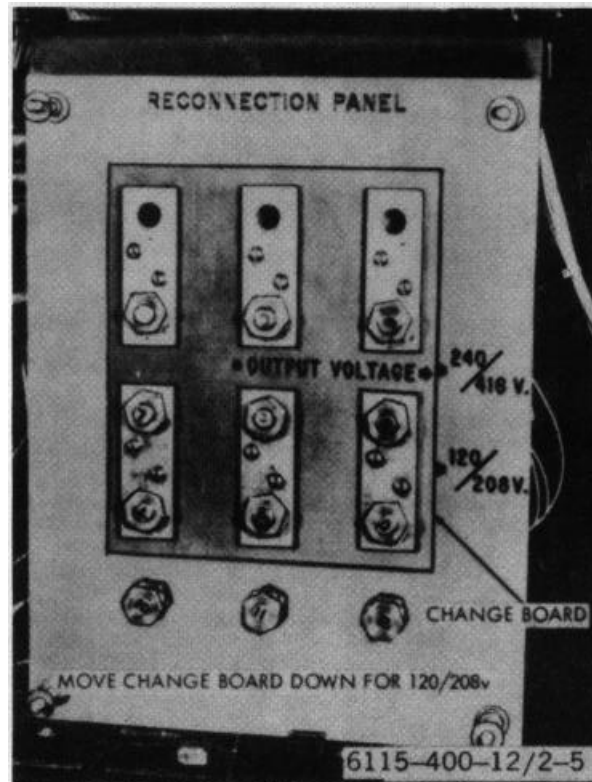

Figure 2-5. Reconnection panel.

Section III. CONTROLS AND INSTRUMENTS

2-9. General

This section describes, locates, illustrates, and furnishes the operator, crew, or organizational maintenance personnel sufficient information about the various controls and instruments for proper operation of the generator set.

2-10. Controls and Instruments

The purpose of the controls and instruments and the normal and maximum reading of the instruments are illustrated in figure 2-6.

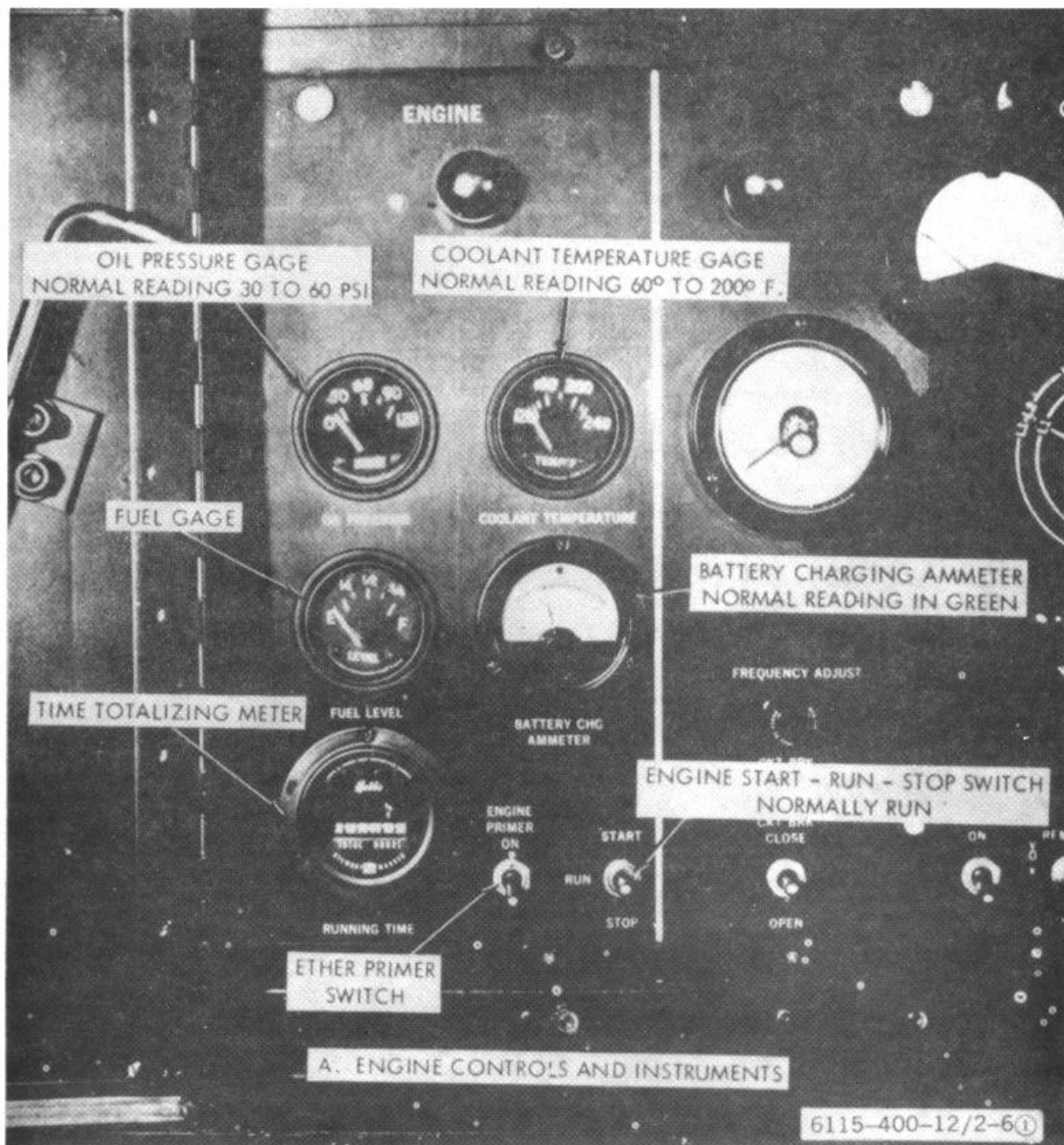

Figure 2-6 (1). Controls and instruments.

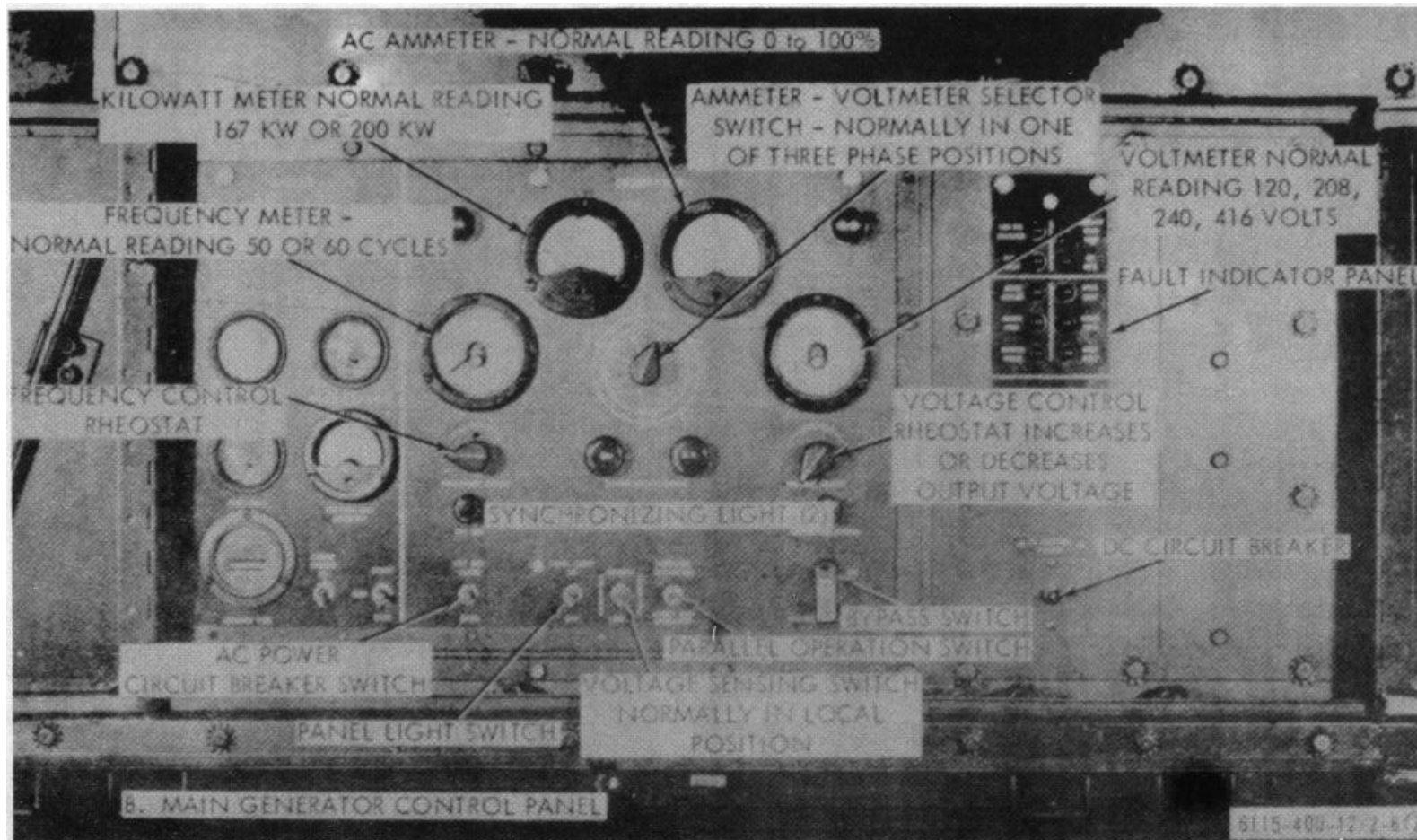

Figure 2-6 (2). Continued.

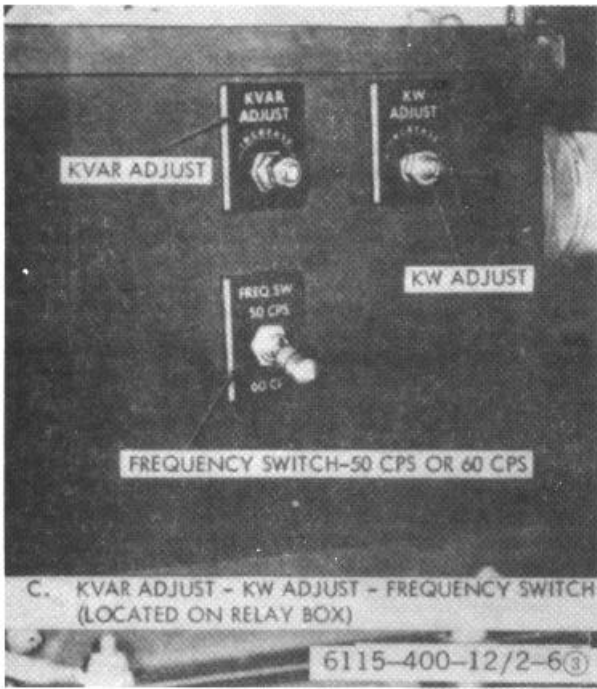

Figure 2-6 (3)-Continued.

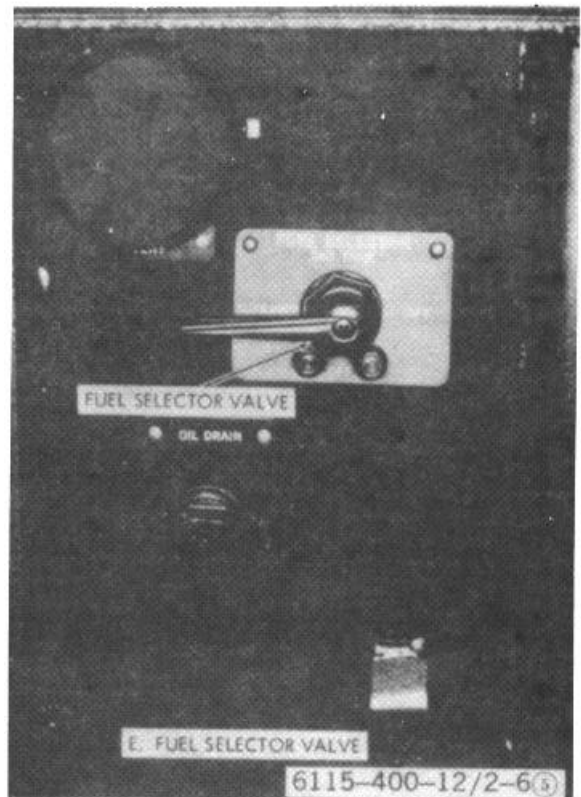

Figure 2-6 (5)-Continued



Figure 2-6 (4)-Continued

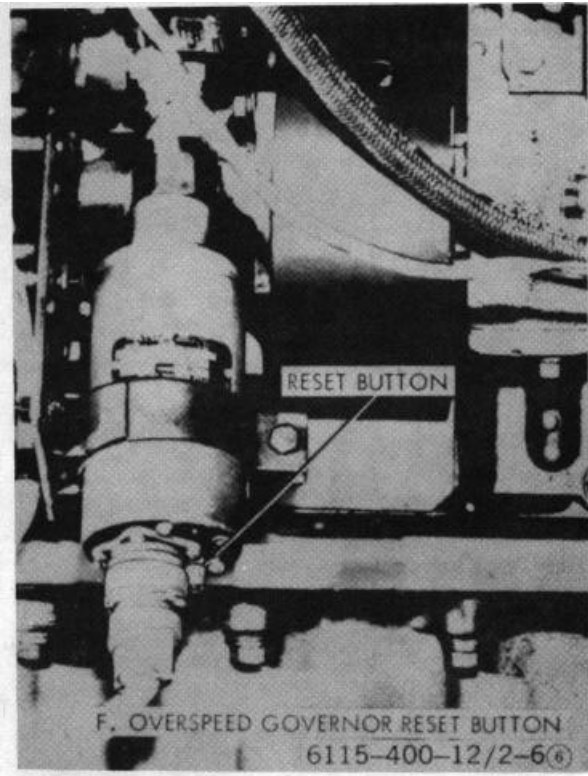

Figure 2-6 (6)-Continued

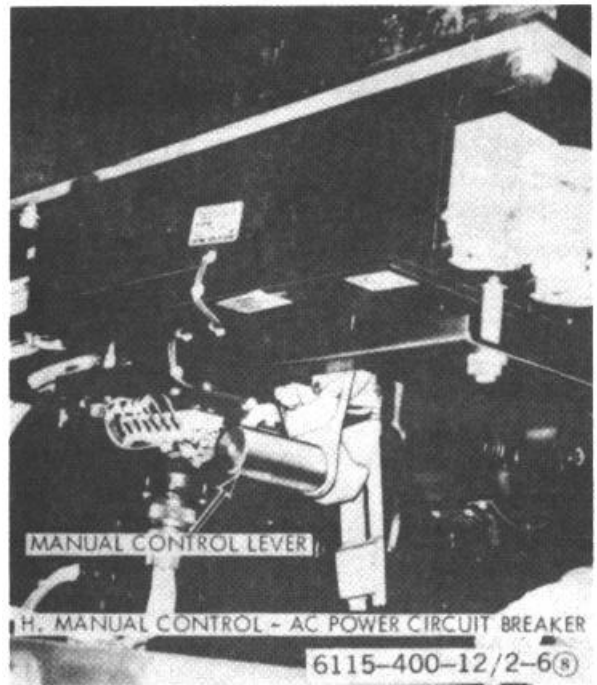

Figure 2-6 (8)-Continued

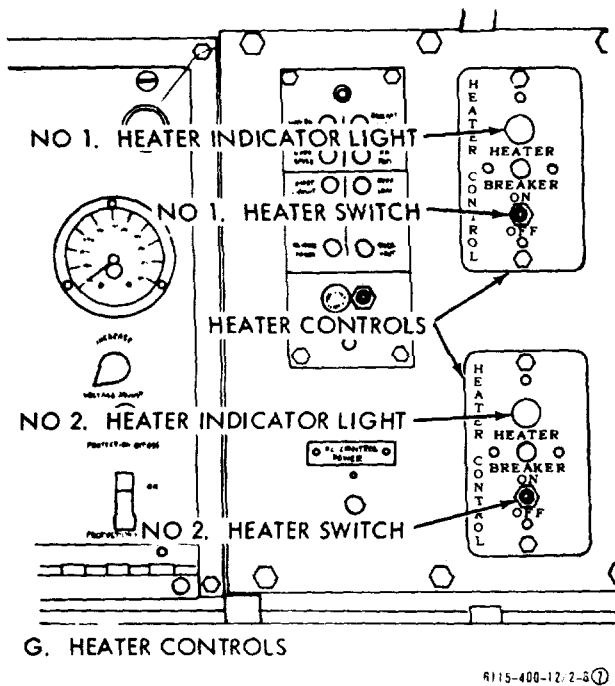

Figure 2-6 (7)-Continued

Section IV. OPERATION OF GENERATOR SET

2-11. General

a. The instructions in this section are published for the information and guidance of the personnel responsible for the operation of the generator set.

b. The operator must know how to perform every operation of which the generator set is capable. This section gives instructions on starting, stopping, single and parallel operation of the generator set. Since nearly every job presents a different problem the operator may have to vary given procedures to fit the individual job.

2-12. Starting

a. *Preparation for Starting.*

- (1) Open the control panel doors and louver doors (fig. 1-1).
- (2) Perform the preventive maintenance checks and services (para 3-6).
- (3) Make the necessary load connections to the generator set (para 2-5).

b. *Normal Starting.* Refer to figure 2-7 and start the unit.

Caution:

Never discharge ether into hot engine.

c. *Cold Weather Starting.* For temperatures below -25°F, refer to the winterization equipment (para 2-22) and ether primer operating instructions (para 2-23).

2-13. Stopping

a. *Normal Stopping.* Refer to figure 2-8 and stop the unit.

b. *Stopping by Safety Devices.* The generator set is equipped with safety devices that will automatically stop the engine in case of high coolant temperature, low oil pressure, engine overspeed, overvoltage, or no fuel. When one of these abnormal conditions occurs, an electrical circuit is broken by the applicable safety device and this causes engine to shut down. A short circuit, overload, undervoltage, or reverse power protective relay will automatically open the AC power circuit breaker but will not stop the engine.

Note.

If an emergency situation requires continued operation of the generator set the protection bypass switch (fig. 2-6 (2)) can be used to override all safety devices except the overspeed and short circuit. Lift over and push switch to ON position. Push the switch to OFF position as soon as possible after the emergency has passed.

2-14. Operation Under Usual Conditions

a. *General.* The generator set can be operated as a single unit or in parallel with other units of this model.

Warning:

Do not operate the generator set unless the ground terminal has been connected to a suitable ground. Electrical faults in the generator set, load lines, or load equipment can cause injury or electrocution from contact with an ungrounded system.

b. *Single-Unit Operation.*

- (1) Determine the load voltage requirements and position the voltage change board for the required voltage (para 2-5).

Caution:

Do not close the AC power circuit breaker until it has been determined that the load is equal to or under the rated capacity of the unit.

- (2) Attach the load cables (para 2-5).
- (3) Set the 50/60 cycle selector switch (fig. 2-6 (3)) for the desired frequency.
- (4) Start the engine (para 2-12).
- (5) Refer to figure 2-9 and operate the generator set as a single unit.

c. *Parallel Operation.*

Note.

Generator sets to be operated in parallel must have the same voltage and frequency rating. They must be connected for the correct phase rotation. The voltage regulation characteristics should be similar and engines should have the same speed regulation characteristics.

- (1) Connect the governor parallel cable between units by plugging the cable into the parallel receptacles of both units.

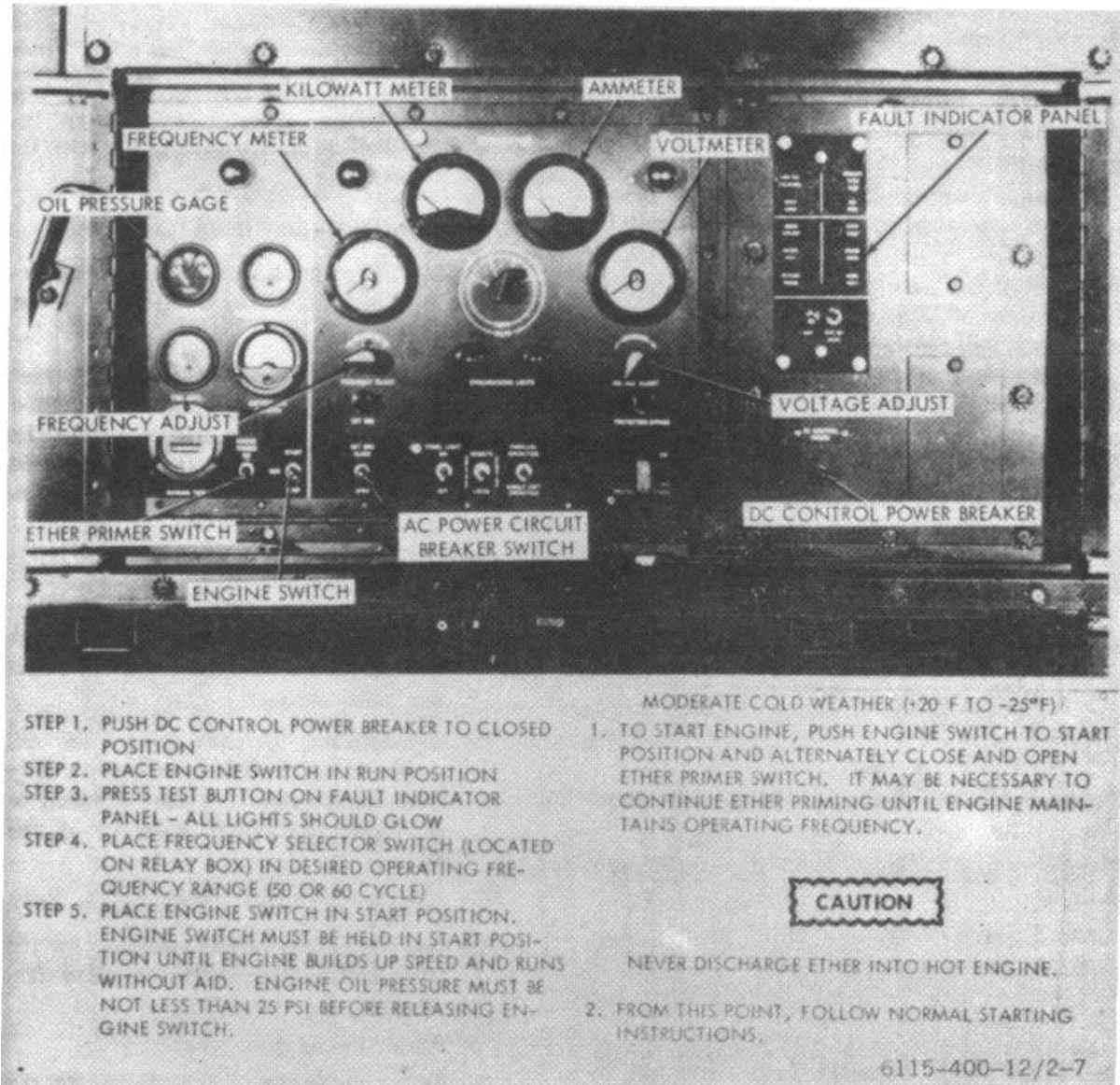

Figure 2-7. Starting instructions.

- (2) Connect a suitable copper wire (No. 6AWG) between the ground terminals of both generator sets to provide a common ground. See that both units are properly grounded (para 2-5).

Warning:

Before making connections for parallel operation, be sure the generator sets are not operating 2-12 and that all switches are in the off

position. Electrical faults in the generator set, load lines, and load equipment can cause injury or electrocution from contact with an ungrounded system.

- (3) Connector jumper cables between like load terminals of each unit (L1 to L1, L2 to L2, etc.) (para 2-5).

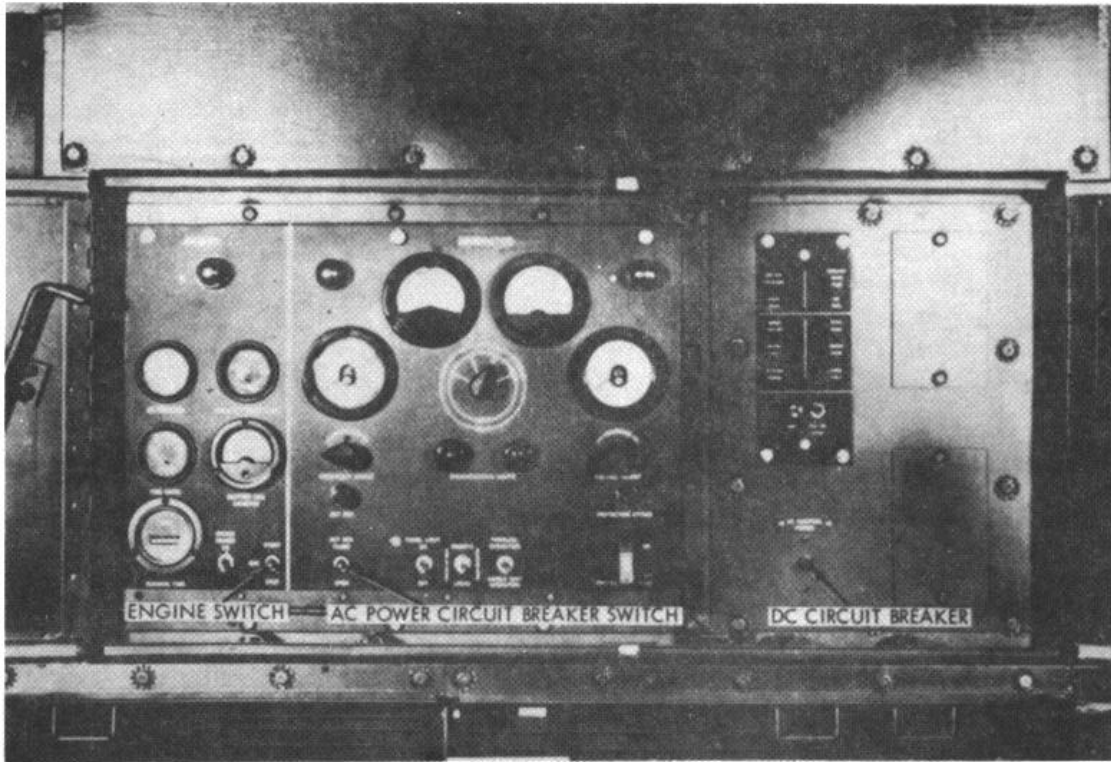

- STEP 1. REMOVE LOAD (PUSH CIRCUIT BREAKER SWITCH TO OPEN POSITION).
- STEP 3. STOP ENGINE BY PUSHING ENGINE SWITCH TO OFF POSITION

- STEP 4. AFTER ENGINE HAS STOPPED, PULL DC POWER CIRCUIT BREAKER TO OPEN.
- STEP 2. ALLOW ENGINE TO OPERATE FIVE (5) MINUTES AT NO LOAD

6115-400-12/2-8

Figure 2-8. Stopping instructions.

- (4) voltage change boards of both units for the selected operating voltage (para 2-6).
- (5) Designate one unit as the operating unit and connect the load cable to this unit. Consider the other unit as incoming unit.
- (6) Refer to figure 2-10 and operate the generator sets in parallel.

Note.

When parallel switch of each unit is on the synchronizing lights of incoming unit should light. Synchronizing lights of operating unit should remain off.

Caution:

Do not close the circuit breaker of the

incoming unit while the synchronizing lights are on. Damage to one or both sets may result.

- d. Removal from Parallel Operation. Refer to figure 2-11 and remove the generator set from parallel operation.

Caution:

Before removing a generator set from parallel operation, see that the load does not exceed the full rating of the remaining set.

Warning:

If necessary to move generator set, stop remaining set or sets before detaching load terminal wires or ground wires.

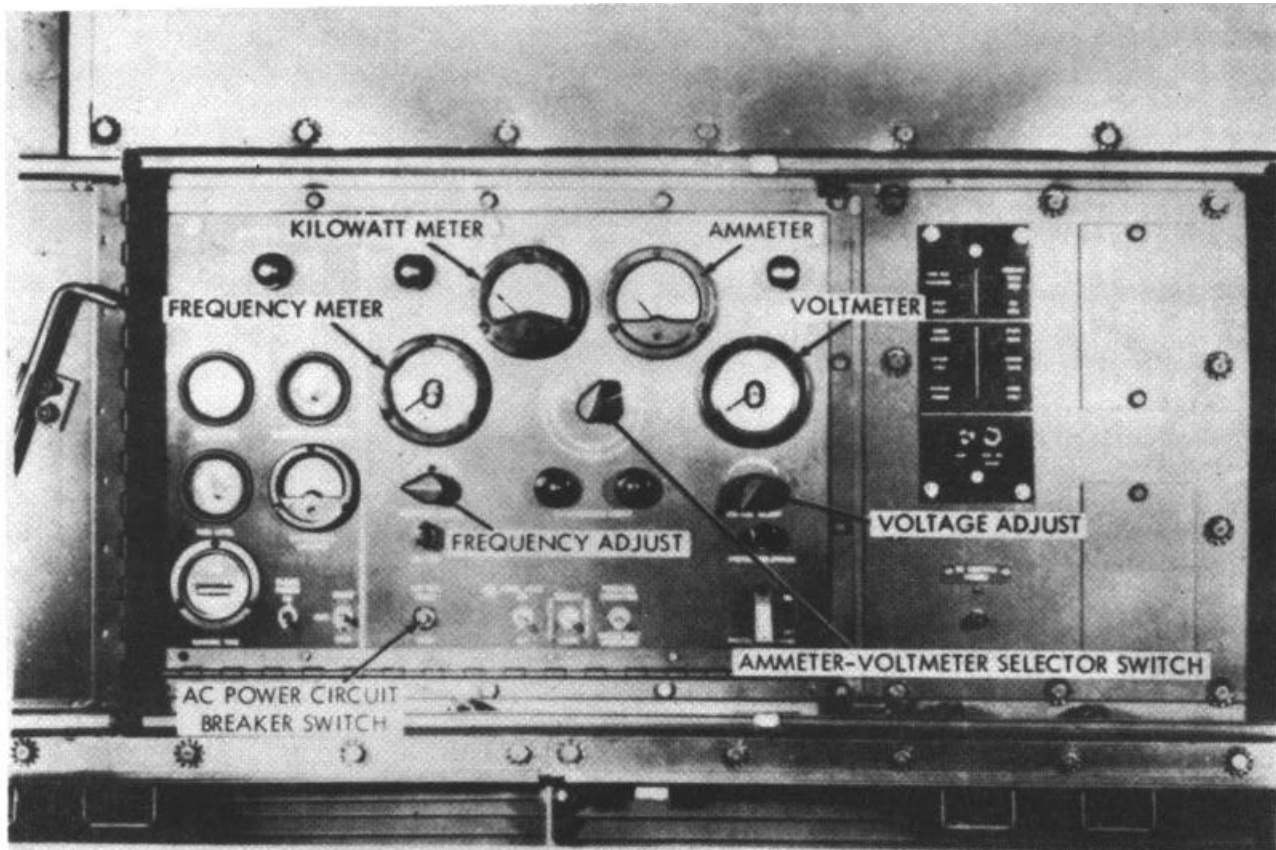

- STEP 1. START AND RUN THE GENERATOR SET
- STEP 2. ADJUST THE VOLTAGE CONTROL RHEOSTAT FOR THE DESIRED VOLTMETER READING
- STEP 3. ADJUST FREQUENCY CONTROL RHEOSTAT FOR DESIRED FREQUENCY METER READING

CAUTION

DO NOT CLOSE THE AC POWER CIRCUIT BREAKER UNTIL IT HAS BEEN DETERMINED THAT THE LOAD IS EQUAL TO OR UNDER THE RATED CAPACITY OF THE UNIT

- STEP 4. APPLY LOAD TO UNIT BY SETTING AC CIRCUIT BREAKER IN THE CLOSE POSITION.
- STEP 5. OBSERVE VOLTMETER. READJUST THE VOLTAGE CONTROL RHEOSTAT TO THE DESIRED OPERATING VOLTAGE IF NECESSARY
- STEP 6. PLACE AMMETER-VOLTMETER SELECTOR SWITCH SEQUENTIALLY TO EACH PHASE POSITION WHILE OBSERVING AC AMMETER. IF MORE THAN RATED LOAD IS INDICATED FOR ANY PHASE POSITION, REDUCE LOAD OR REPORT THE CONDITION TO ORGANIZATIONAL MAINTENANCE
- STEP 7. OBSERVE KILOWATT METER READING. IF MORE THAN RATED KW IS INDICATED, REDUCE LOAD OR REPORT THE CONDITION TO ORGANIZATIONAL MAINTENANCE

6115-400-12/2-9

Figure 2-9. Single unit operation.

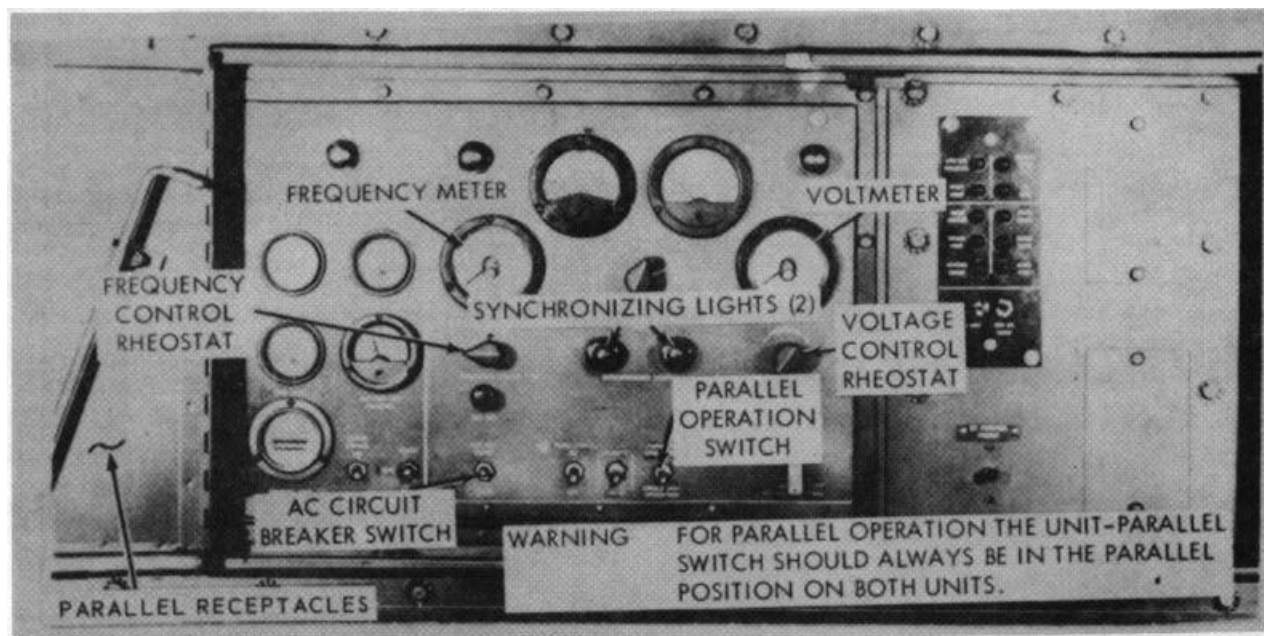

- STEP 1. PLACE OPERATING UNIT IN SINGLE-UNIT OPERATION (FIG. 13)
 STEP 2. START INCOMING UNIT.

CAUTION
 DO NOT CLOSE THE CIRCUIT BREAKER ON THE INCOMING UNIT AT THIS TIME.

- STEP 3. PLACE PARALLEL SWITCH OF EACH UNIT IN THE UNIT PARALLEL POSITION.

NOTE
 SYNCHRONIZING LIGHTS OF INCOMING UNIT SHOULD LIGHT. SYNCHRONIZING LIGHTS OF OPERATING UNIT SHOULD REMAIN OFF

- STEP 4. OBSERVE VOLTMETER AND FREQUENCY METER OF EACH UNIT FOR PROPER READINGS.
 STEP 5. OBSERVE SYNCHRONIZING LIGHTS OF INCOMING UNIT. LIGHTS SHOULD GO ON AND OFF SIMULTANEOUSLY. IF LIGHTS GO ON AND OFF ALTERNATELY, UNITS ARE OUT OF PHASE. STOP BOTH SETS (PAR. 18), AND REVERSE ANY TWO INTERCONNECTING JUMPER CABLE LEADS AT TERMINALS L1, L2, OR L3 OF INCOMING UNIT. DO NOT INTERCHANGE THE LEAD AT LO TERMINAL. REPEAT STEPS 1 THROUGH 4.
 STEP 6. ADJUST FREQUENCY CONTROL RHEOSTAT OF INCOMING UNIT UNTIL SYNCHRONIZING LIGHTS GO ON AND OFF SLOWLY AT 2 TO 3 SECOND INTERVALS.
 STEP 7. CAREFULLY OBSERVE FLUCTUATING SYNCHRONIZING LIGHTS AND AT THE INSTANT BOTH LIGHTS ARE DARK, CLOSE THE CIRCUIT BREAKER OF THE INCOMING UNIT. THE GENERATOR SETS ARE NOW OPERATING IN PARALLEL.

CAUTION
 DO NOT CLOSE THE CIRCUIT BREAKER OF THE INCOMING UNIT WHILE THE SYNCHRONIZING LIGHTS ARE ON. DAMAGE TO ONE OR BOTH SETS MAY RESULT.

6115-400-12/2-10

Figure 2-10. Parallel operation.

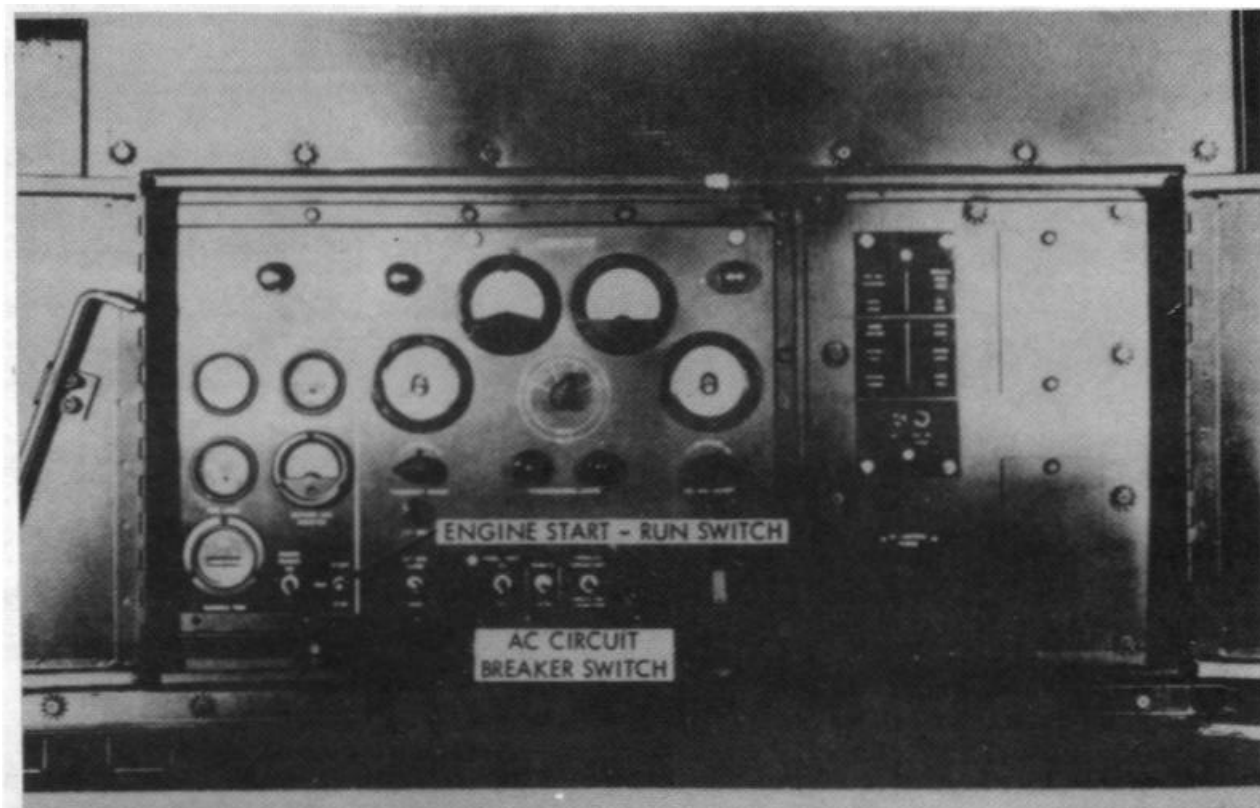

Figure 2-11. Removal of parallel operation.

Section V. OPERATION UNDER UNUSUAL CONDITIONS

2-15. Operation in Extreme Cold (Below -25°F.)

Caution: Do not close the circuit breaker on the incoming unit at this time.

Note. Synchronizing lights of incoming unit should light. Synchronizing lights of operating unit should remain off.

a. General. The generator set is designed to operate in temperatures down to -25°F without winterization equipment. To operate successfully at temperatures below -25°F the engine must be heated by integrally mounted winterization heating equipment and started by an auxiliary kit providing heated batteries (para 2-22).

b. *Fuel System.* Keep the fuel tank as full as possible to prevent condensation of moisture. Be sure to use the proper grade of fuel for existing temperature. See table below. Service the fuel filters and strainers more frequently than usual. Remove ice, snow, and moisture from the filler cap and filler neck.

Caution: Do not close the circuit breaker of the incoming unit while the synchronizing lights are on. Damage to one or both sets may result.

Table 2-2. Fuels (Engine and Heater).

Name	Specification	Type/grade	Ambient air temperature
Diesel	VV-F-800	DF-2 DF-1 DF-A	Above 20°F. -25°F. to 20°F. Below -25°F.
Cite	F-4121	---	All temperatures
Jet	J-5624	JP-4	All temperatures

c. *Engine Electrical System.* Clean the batteries and cables and inspect for cracked or damaged cases. Be sure the battery terminals are tight, clean, and lightly greased. See that the battery cap ventholes are open. The electrolyte level must be three-eighths inch above the plates. To prevent the batteries from freezing, see that they are kept fully charged. Inspect all electrical wiring for cracks, breaks, and fraying. Tighten loose connections.

Note. After adding water to the batteries in freezing temperatures, run the engine for at least an hour to thoroughly mix the water with the electrolyte.

d. *Lubrication.* Lubricate the generator set in accordance with the current lubrication order.

e. *Cooling System.* Inspect the level of the coolant in the radiator. Inspect the cooling system for leaks, paying particular attention to gaskets and hose connections. See that antifreeze solution is correct for the lowest temperature expected. Refer to table 21.

Caution: Before removing a generator set from parallel operation, see that the load does not exceed the full rating of the remaining set.

Warning: If necessary to move generator set, stop remaining set or sets before detaching load terminal wires or ground wires.

2-16. Operation in Extreme Heat

a. Keep the cooling system free from rust and scale. If necessary, add an approved rust inhibitor. Avoid, if possible the use of alkaline water or salt water, which might cause the accumulation of rust and scale. Make sure that the engine thermostat and shutter thermostat are in proper working order. Inspect the V-belts for proper adjustment (para 3-11). Be sure that the generator set is free of dust and dirt.

b. Lubricate the engine in accordance with the current lubrication order (fig. 3-1).

c. Do not fill the fuel tank too full; allow sufficient room for expansion of fuel.

d. Inspect the electrolyte level of the batteries daily. The plates should be covered with three-eighths inch of water. Add water if necessary.

e. Be sure that the generator is free of airflow restrictions. When operating indoors, make provisions for adequate ventilation and the venting of exhaust fumes to the outside.

2-17. Operation in Dusty or Sandy Areas

a. Where water is available, keep the immediate area wetted down. Keep the unit as clean as possible, paying special attention to the screens and grilles.

b. In dusty or sandy areas, filters and strainers must be cleaned more frequently than under normal conditions. Clean all lubrication points before and after lubrication. Be sure that all lubricant containers are tightly sealed and stored in an area free from dust and sand.

c. Take all necessary precautions to keep dirt and grit out of the fuel tank.

2-18. Operating Under Rainy or Humid Conditions

Keep the fuel tank full to prevent forming of condensation. During dry periods when the set is not operating, open the doors, and allow the set to dry out.

2-19. Operation in Salt Water Areas

a. Salt water causes corrosive action on metal. Care must be taken to avoid contact of

equipment with salt water. If contact is made, or if the unit is exposed to salt spray, wash the unit frequently with clean, fresh water.

b. Paint all exposed non-polished surfaces. Coat all exposed polished surfaces with approved, rust-proofing material.

Section VI. OPERATION OF AUXILIARY MATERIEL USED IN CONJUNCTION WITH THE GENERATOR SET

2-21. Fire Extinguisher

(Monobromotrifluoromethane Type)

a. Description. The monobromotrifluoromethane type fire extinguisher is generally suitable for all types of fire, except fires involved with LOX (liquid oxygen) generating equipment. The fire extinguisher is furnished with a disposable-type cylinder.

b. Operation. To operate the fire extinguisher, perform the following:

- (1) Remove the fire extinguisher from its location.
- (2) Break seal by pulling safety pin from handle.
- (3) Point horn at base of flame.
- (4) Press trigger for discharge and direct stream at base of flame.
- (5) Replace cylinder immediately after using.

c. Replacement of Cylinder. To replace cylinder, perform the following:

- (1) Press lever to release pressure from used cylinder.
- (2) Loosen swivel valve coupling nut and remove valve assembly from cylinder.
- (3) Remove instruction band from used cylinder.
- (4) Place new cylinder through instruction band.
- (5) Replace safety pin in valve and seal pin with sealing wire.
- (6) Attach valve assembly and tighten swivel coupling nut on the new cylinder and place fire extinguisher in mounting bracket.
- (7) Adjust instruction band on cylinder to show maintenance and operating instructions.

2-20. Operation at High Altitudes

The generator set is designed to operate at elevations up to 8,000 feet above sea level without special adjustment. Provide adequate ventilation as the engine is more likely to overheat at high altitudes.

d. Maintenance. Weigh the fire extinguisher every 3 months and replace cylinder if gross weight has decreased 4 ounces or more. Lubricate cylinder neck treads with one drop of OE 30 oil before reassembly.

2-22. Winterization Equipment

a. General. Winterization equipment for starting the engine when temperatures are below -25°F., consists of two kits as follows:

- (1) A generator set kit including two heaters, coolant lines, fuel line, electrical controls, and mounting hardware to be installed in the set for preheating the engine oil pan and cooling system. The heaters are designed to use a variety of fuels and can be operated on any fuel available from the diesel engine fuel system.
- (2) A portable auxiliary winterization kit is also available to provide separate heated and charged batteries. This kit includes a heater for heating the auxiliary batteries and a battery charger which can be connected to any 110V, 50/60 or 400 CPS power supply.

b. Operation.

- (1) Generator set heaters.
 - (a) Refer to figure 2-12 to start and operate the heaters.
 - (b) Refer to figure 2-13 to stop the heaters.

2-23. Ether Primer Operation

Refer to figure 2-14 for operation of the ether primer.

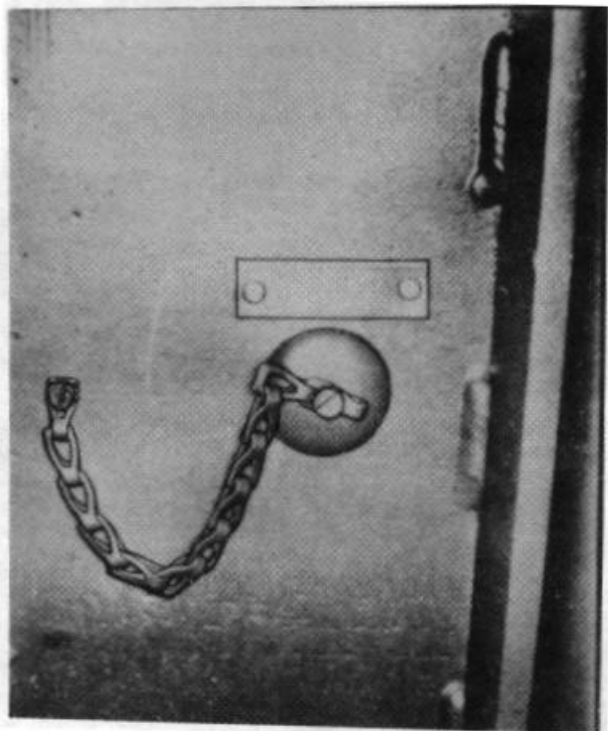
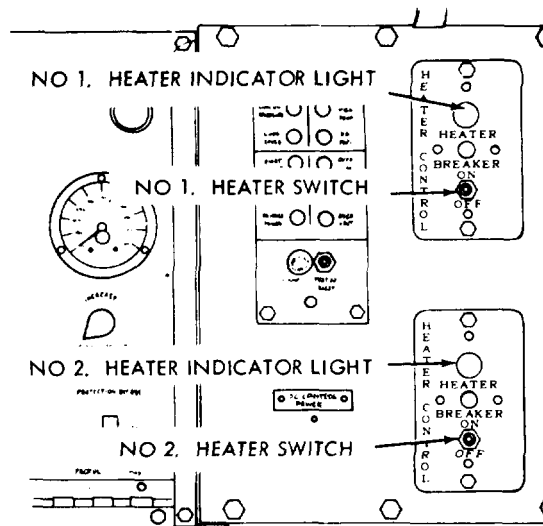

Figure 2-12 (1). Heater starting and operating instructions.
6115-400-12/2-12 (1)

Note. When heater indicator lights burn automatically the heaters are lighted and starting to heat the unit.

Note. If after two minutes a heater is not lit, turn heater control switch off for above two minutes before attempting to restart the heater.

Caution: Never discharge ether into hot engine.



STEP 4. TURN HEATER CONTROL SWITCHES TO ON POSITION. (DO NOT START BOTH HEATERS AT SAME TIME)

NOTE
WHEN HEATER INDICATOR LIGHTS BURN AUTOMATICALLY THE HEATERS ARE LIGHTED AND STARTING TO HEAT THE UNIT.

STEP 5. CLOSE ALL DOORS AND SIDE PANELS.

NOTE
IF AFTER TWO MINUTES A HEATER IS NOT LIT, TURN HEATER CONTROL SWITCH OFF FOR ABOUT TWO MINUTES BEFORE ATTEMPTING TO RESTART THE HEATER.

STEP 6. AFTER AN INTERVAL OF APPROXIMATELY ONE HOUR AFTER THE HEATERS HAVE OPERATED, START THE UNIT AND OPEN CONTROL PANEL AND LOUVER DOORS.

6115-400-12/2-12 (2)

Position valves.
Figure 2-12 (2)-Continued.

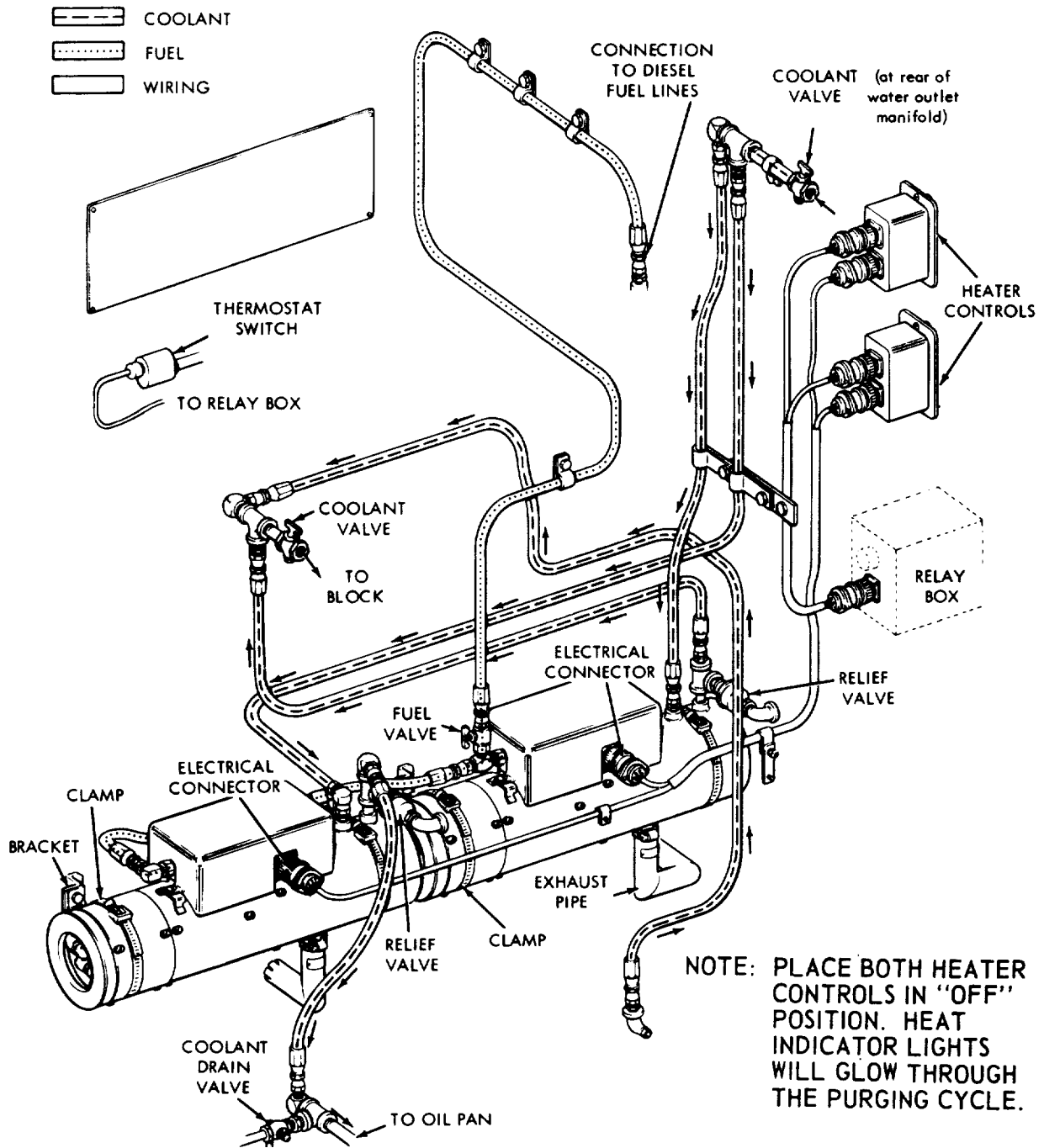

STEP 2.
STEP 3.

OPEN HEATER VALVE
OPEN COOLANT VALVES (2)

6115-400-12/2-13

Figure 2-13. Heater stopping instructions.

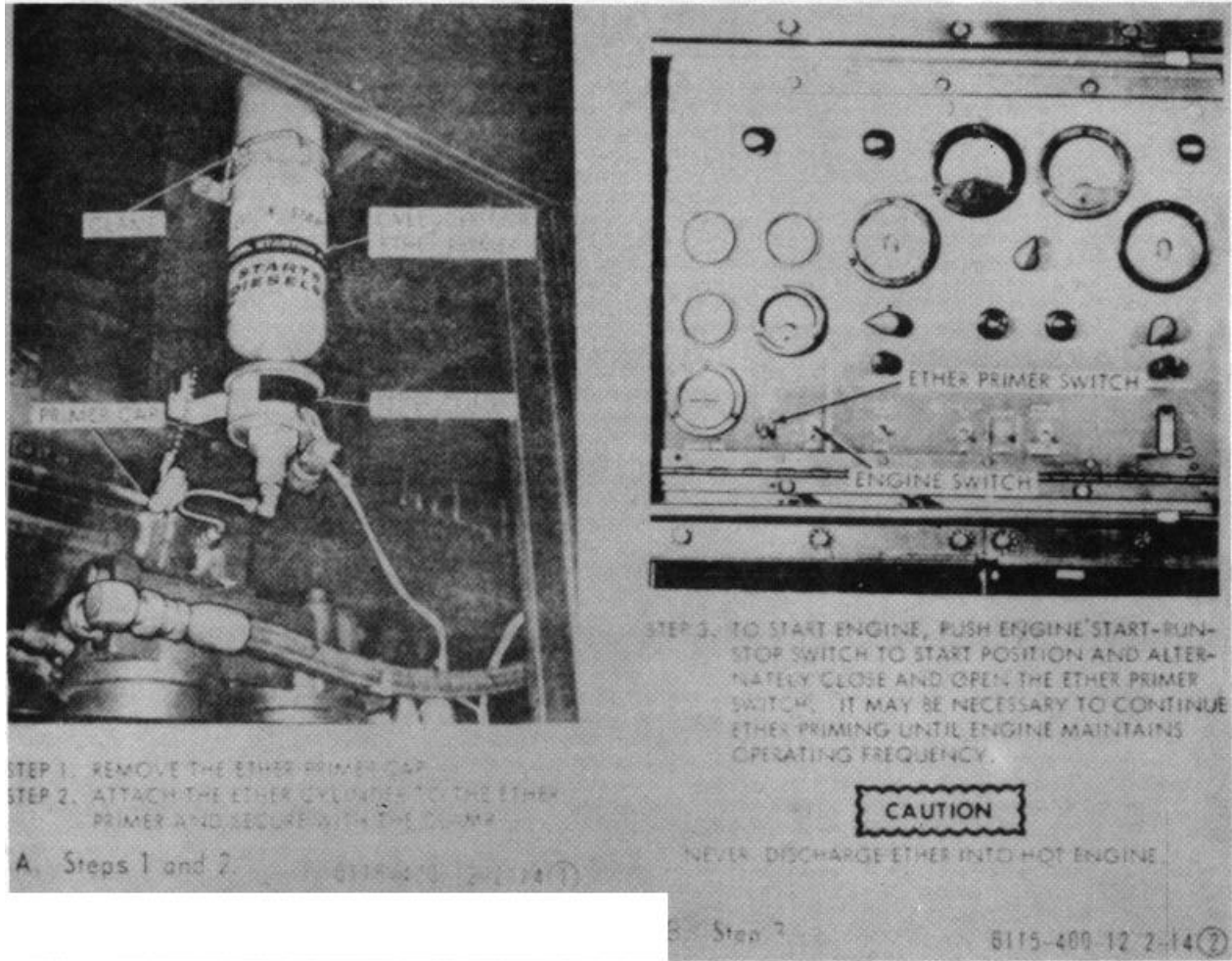

Figure 2-14. (1). Ether primer operating instructions.

Figure 2-14-(2) - Continued.

**CHAPTER 3
OPERATOR'S AND ORGANIZATIONAL MAINTENANCE
INSTRUCTIONS**

**Section I. OPERATOR'S AND ORGANIZATIONAL MAINTENANCE
TOOLS, AND EQUIPMENT**

3-1. Tools and Equipment

The special tools required to perform organizational maintenance on the generator set are listed in table 3-1. References indicating the use of these tools are listed in the table. Tools and repair parts issued with or authorized for the generator set are listed in the Basic Issue Items List, Appendix B of this manual.

3-2. Organizational Maintenance Repair Parts

Organizational Maintenance repair parts are listed and illustrated in TM 5-6115-400-25P (when printed).

Section II. LUBRICATION

3-3. General Lubrication Information

a. This section contains a reproduction of the lubrication order and lubrication instructions which are supplemental to, and not specifically covered in the lubrication order.

b. The lubrication order shown in figure 3-1 is an exact reproduction of the approved lubrication order for the generator set.

Table 3-1. Special Tools.

Item	FSN or Part Number	Reference		Use
		Figure	Paragraph	
Baring lever	(09367) 4444698	3-14	3-56	Bar engine over for valve adjustments.
Wrench	(13786) 6004	2-3	2-5	Tighten load terminal nuts.

3-4. Detailed Lubrication Information

a. *Care of Lubricants.* Keep all lubricants and lubricating equipment clean and free from foreign material. Open containers only in protected areas free from dust and dirt. Clean grease guns, containers, and applicators with cleaning solvent and thoroughly dry before using. Wipe all caps, cover, plates parts and surrounding surfaces with clean rags and solvent before removing them to apply lubricants. Protect all openings

from dust or dirt, and replace covers as soon as lubricant is applied.

b. *Foreign Material or Dirt in the Lubricating System.* Operating the engine with contaminated oil, under the assumption that the oil filter will remove any contaminants before they reach the bearings, can be quite costly. Actually, there are certain conditions under which, if the oil filter is bypassed and if the

LUBRICATION CHART

GENERATOR SET, DIESEL ENGINE: 200KW, AC, 120/208V, 240/416V, 3 PHASE, 60 CYCLE, CONVERTIBLE TO 167KW, 50 CYCLE; SKID MOUNTED (MILITARY STANDARD MODEL SF-200-MD/CIED) W/ALLIS-CHALMERS ENGINE MODEL 25000

Intervals are based on normal hours of operation. Reduce to compensate for abnormal operation and severe conditions. During inactive periods, sufficient lubrication must be performed for adequate preservation.

Clean parts with SOLVENT, dry-cleaning, or with OIL, fuel, Diesel. Dry before lubricating.

Drain crankcase when hot, fill and check level.

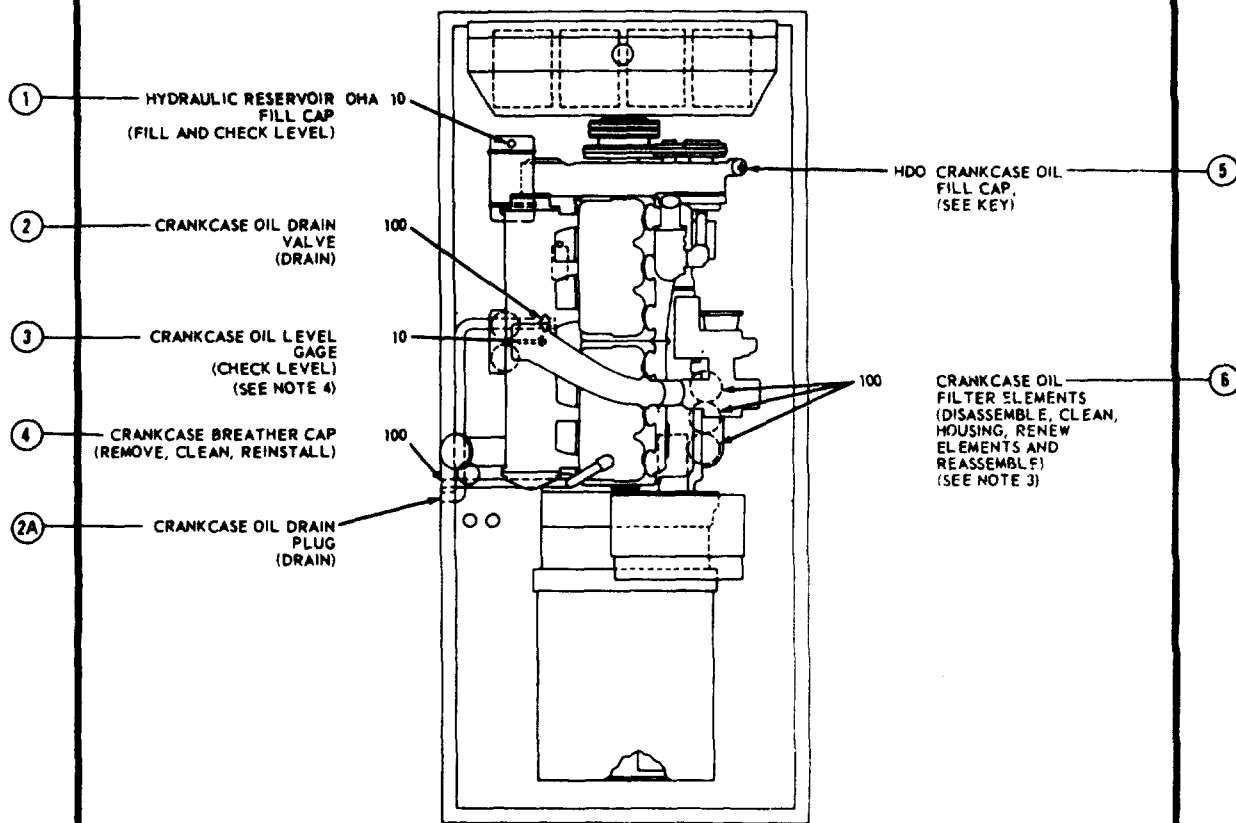

6115-400-12/3-1 ①

Figure 3-1 (1). Lubrication chart.

CONTINUED FROM
PRECEDING PAGE

-KEY-

LUBRICANTS	CAPACITY	EXPECTED TEMPERATURES			INTERVALS
		Above 32°F	40°F to -10°F	0°F to -65°F	
HDO - Oil, Engine High Output Diesel		HDO 30	HDO 10	OES	Intervals given are in hours of normal operation.
Crankcase	44 Qts				
Oil Can Points					
OES - Oil, Engine, Sub-zero		All temperatures			
OHA - Oil, Hydraulic	8 Qts				

NOTES:

1. FOR OPERATION OF EQUIPMENT IN PROTRACTED COLD TEMPERATURES BELOW -10°F. Remove lubricants prescribed in the key for temperatures above -10°F. Clean parts with SOLVENT, dry-cleaning. Relubricate with lubricants specified in the key for temperatures below -10°F.
2. OIL CAN POINTS. Every 100 hours, clean and lightly coat all linkages, hinges and latches with OE.
3. OIL FILTER. After installing new filter element, fill crankcase, operate engine 5 minutes, check filter housing for leaks, check crankcase oil level and bring to full mark.
4. OIL LEVEL GAGE. Gage is marked on both sides. One side indicates static oil level and other side is marked for running oil level.

6115-400-12/3-1 ②

Figure 3-1 (2) Continued.

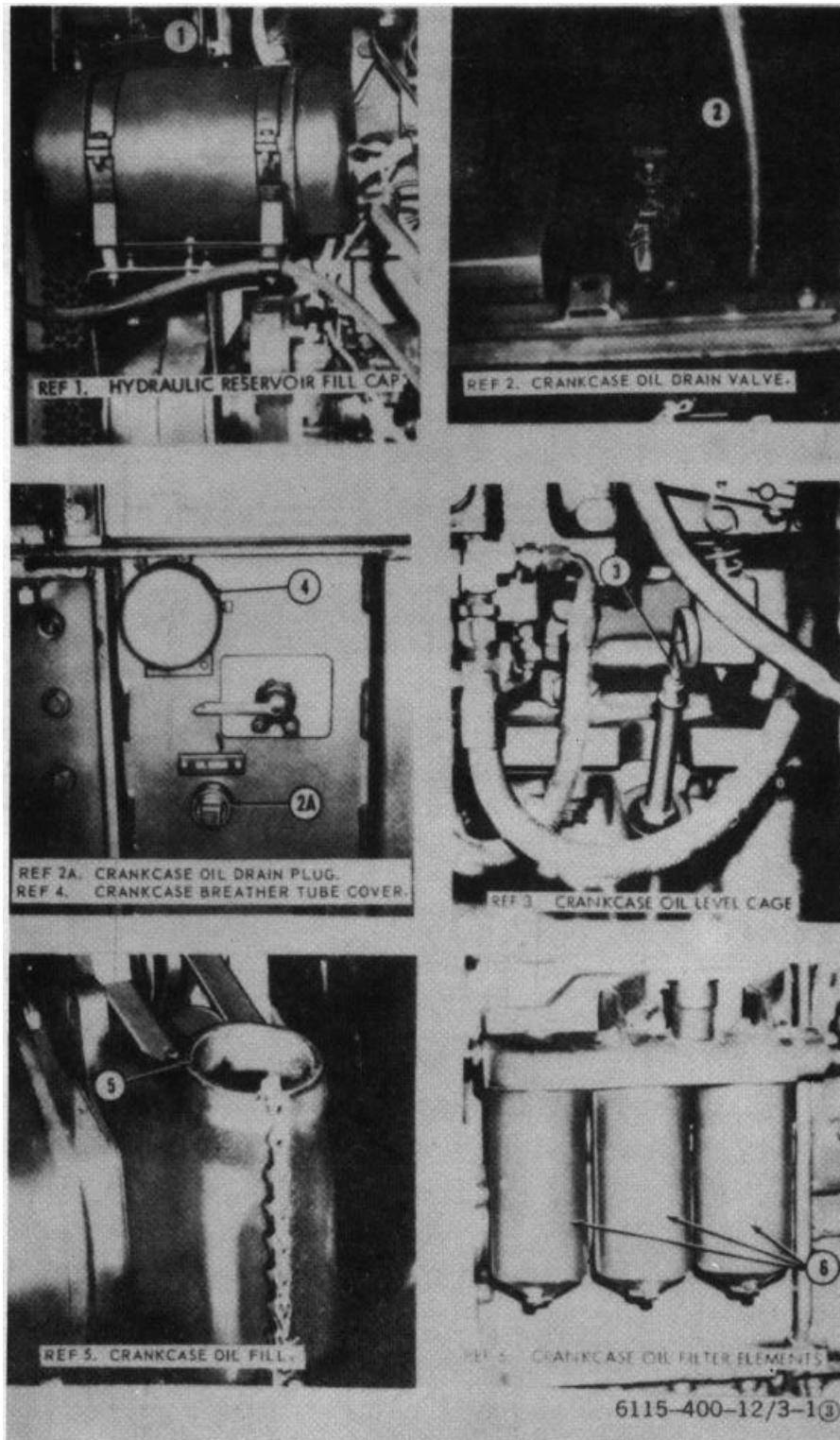

Figure 3-1 (3) - Continued.

oil is contaminated, turbocharger damage can result. Some examples of instances where the filter will be bypassed are:

- (1) When the oil filter is clogged and the bypass valve is open.
- (2) When a lube valve or filter bypass valve malfunctions (as a result of worn or binding components).

Contaminated oil will actually cause damage to the turbocharger bearings when this oil is permitted to enter

in an amount sufficient to wear out the turbocharger bearings or when the contaminating particles are large enough to plug the internal oil passages and starve the turbocharger for oil.

c. Use of Time Totalizing Meter to Determine Lubricating Intervals. The established intervals in the lubricating chart and maintenance instructions are given in service hours. The intervals indicated are for normal service.

Section III. PREVENTIVE MAINTENANCE CHECKS AND SERVICES

3-5. General

To insure that the generator set is ready for operation at all times, it must be inspected systematically, so that defects may be discovered and corrected before they result in serious damage or failure. The necessary Preventive Maintenance Checks and Services to be performed are listed and described in paragraph 3-6. The item numbers indicate the sequence of minimum inspection requirements. Defects discovered during operation of the unit shall be noted for future correction, to be made as soon as operation has ceased. Stop operation immediately if a deficiency is noticed during operation which would damage the equipment if

operation were continued. All deficiencies and shortcomings will be recorded together with the corrective action taken on DA Form 2404 at the earliest possible opportunity.

3-6. Preventive Maintenance Checks and Services

This paragraph contains a tabulated listing of preventive maintenance services which must be performed by the operator. The item numbers are listed consecutively and indicate the sequence of minimum requirements.

Table 3-2. Preventive Maintenance Checks and Service

Item Number	Interval						B - Before operation D - During operation	A - After operation W - Weekly	M - Monthly Q - Quarterly	Reference
	Operator				Org.					
	Daily				M	Q	Item to be inspected	Procedure		
	B	D	A	W						
1	*	*	*	*	*				para 3-11	
2	*	*	*	*	*	*			para 2-10 fig. 3-53	

Table 3-2. Preventive Maintenance Checks and Services-Continued

Item Number	Interval						B - Before operation	A - After operation	M - Monthly
	Operator				Org.		D - During operation	W - Weekly	Q - Quarterly
	B	D	A	W	M	Q	Item to be inspected	Procedure	Reference
8		*				*	Fire extinguisher	Check for broken seal. Weigh new or charred extinguisher 4 ounce loss maximum.	para 2-21
4	*	*		*		*	Ground terminal	Check for adequate grounding.	para 3-14
5	*	*	*				Collector manifold	Open drain cock daily. Leave open during shutdown period. Drain cock MUST be closed during engine operation.	
6	*	*	*				Fuel tank	Fill as necessary. Clean cap vent.	para 3-16
7	*	*	*	*	*	*	Oil level gage	Keep oil at "FOLD" on indicator. Check current lubrication order.	
8	*		*			*	Fuel filters	Drain sediment and water from fuel filters.	para 3-30
9	*				*	*	Hydraulic tank	Check fluid level, add fluid as required.	para 3-30
10	*	*		*		*	Batteries	Inspect defective tank. Tighten loose connections. Remove corrosion. Check for cracks and leaks. Fill to 3/8 inch above plates. Clean vent holes in caps. Replace a cracked battery.	fig. 2-2
11	*	*					Radiator	Coolant lever is 2 inches below neck. Correct cap pressure is 7 lbs.	para 3-46
12						*	Air cleaner	Check restriction indicator.	para 3-8
13	*	*					Vibration or noise	Be on alert for unusual noise or excessive vibration.	
14					*	*	Main generator brushes and sliprings.	Check for frayed wiring. Clean or smooth dirty or rough sliprings. Replace brushes if worn to 1/2 original size.	para 3-63

Section IV. OPERATOR'S MAINTENANCE

3-7. General

The instructions in this section are published for the information and guidance of the operator to maintain the generator set.

3-8. Air Cleaner

Check air restriction indicator daily. If red signal is visible, service the air cleaner as described in figure 3-2.

3-9. Fuel Tank

- a. *Fuel Tank Cap and Strainer.*
 - (1) *Removal and Installation.* Refer to figure 3-3 and remove the fuel tank cap and gasket and strainer.
- b. *Fuel Drains.*
 - (1) Fuel drains are located at both corners of the fuel tank at the control panel end of the generator set. See figure 3-4.



Figure 3-2. Air cleaner service.

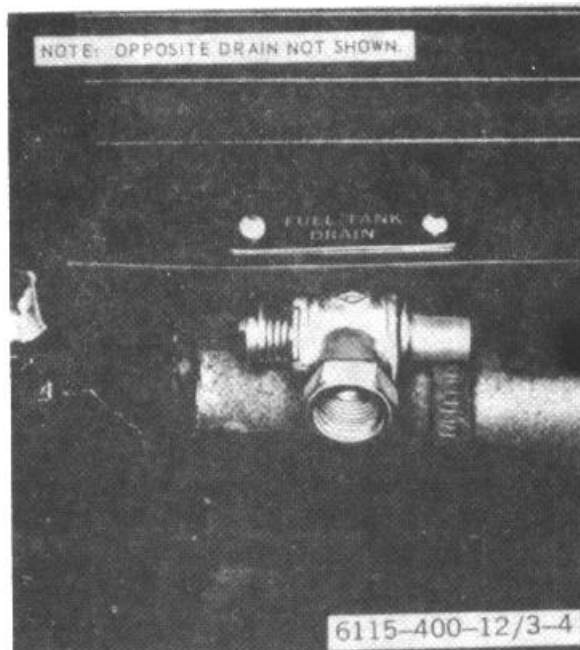

Figure 3-4. Fuel tank drains.

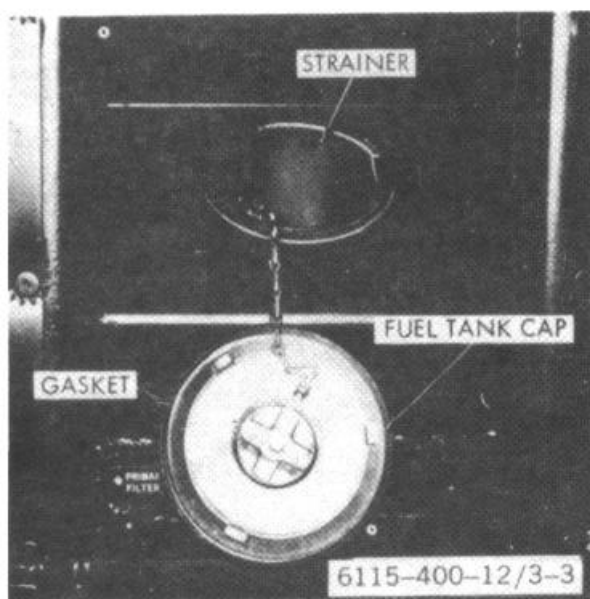

Figure 3-3. Fuel Tank service.

- (2) Open fuel drains and allow water and sediment to completely drain off. Close drain cocks when clean diesel fuel runs out.

3-10. Fuel Strainer and Filters

Refer to figure 3-5 and drain the fuel strainer and filters. Drain before the start of daily operations in warm weather or shortly after the end of daily operations in freezing weather.

3-11. Fan Belts

Refer to figure 3-6 and adjust the fan belts.

3-12. Water Pump and Battery Charging Generator Belts

Refer to figure 3-7 and adjust the water pump belt and generator belts.

3-13. Lamps and Fuses

Removal and Installation. Refer to figure 3-8 and remove the incandescent lamps. If necessary remove one ampere fuse in fault indicator panel and 15 ampere fuse in convenience receptacle compartment under fire extinguisher.

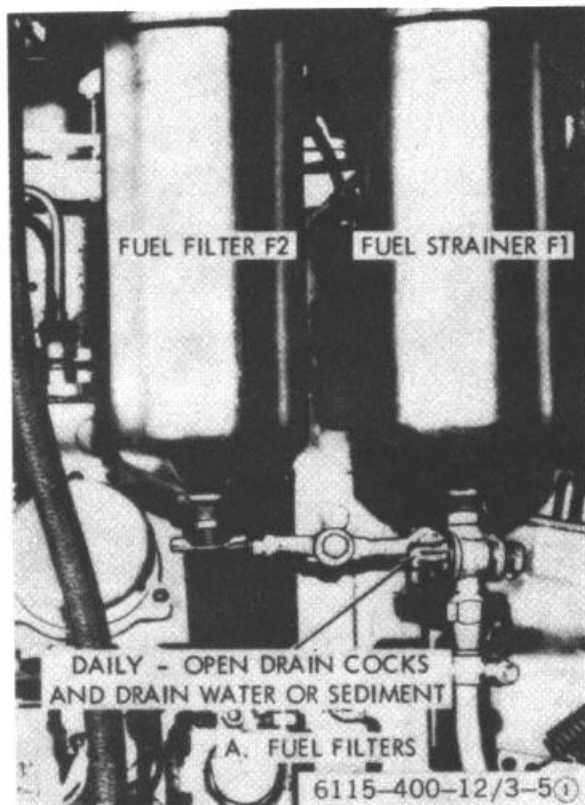

Figure 3-5 (1). Fuel strainer and filter service.

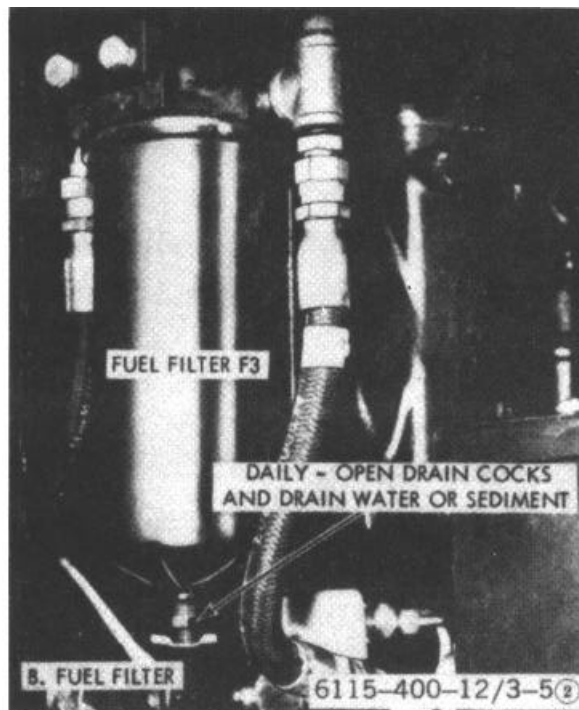

Figure 3-5 (2)-Continued.

3-14. Intake Manifold Moisture Collector

a. *General.* A collector manifold (fig. 39) is connected to each port of the intake manifold to collect any condensation that may collect in the intake manifold during shutdown periods.

b. *Draining.* Open the drain cock daily to drain any accumulation of water in the collector manifold.

Note. The drain cock must be closed when the engine is operating.

Caution: If a considerable amount of coolant has drained from the collector manifold, the intercooler should be checked for leaks.

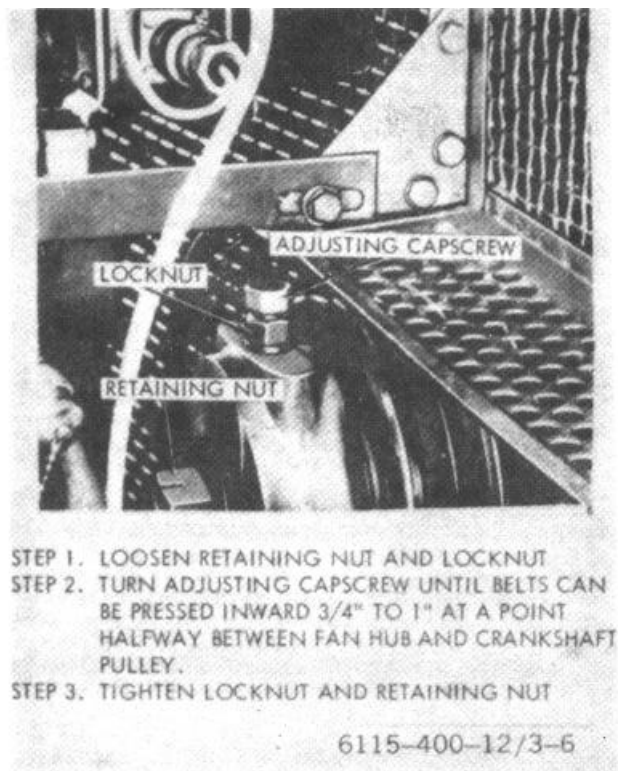
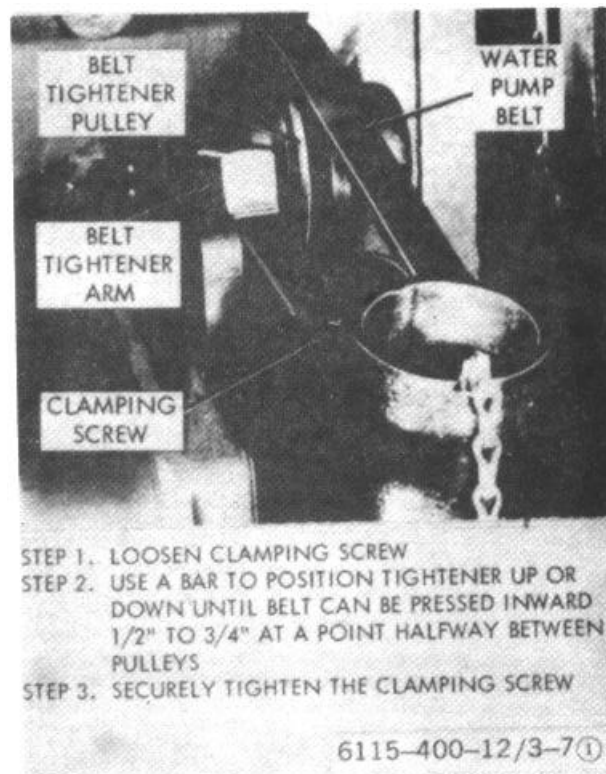
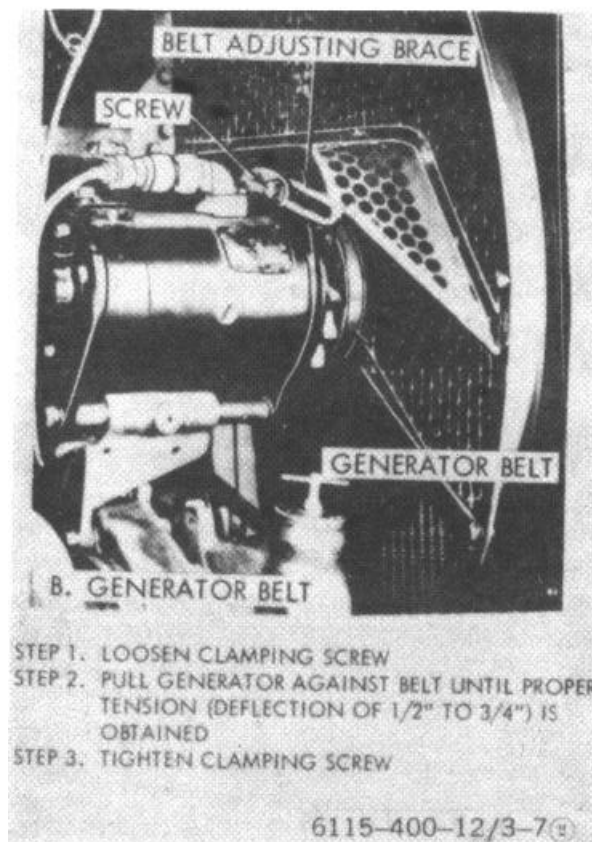

Figure 3-6. Adjusting fan belts.



Water pump belt.

Figure 3-7. (1). Adjusting water pump and battery charging generator belts.



Generator belt.
Figure 3-7 (2)-- Continued.

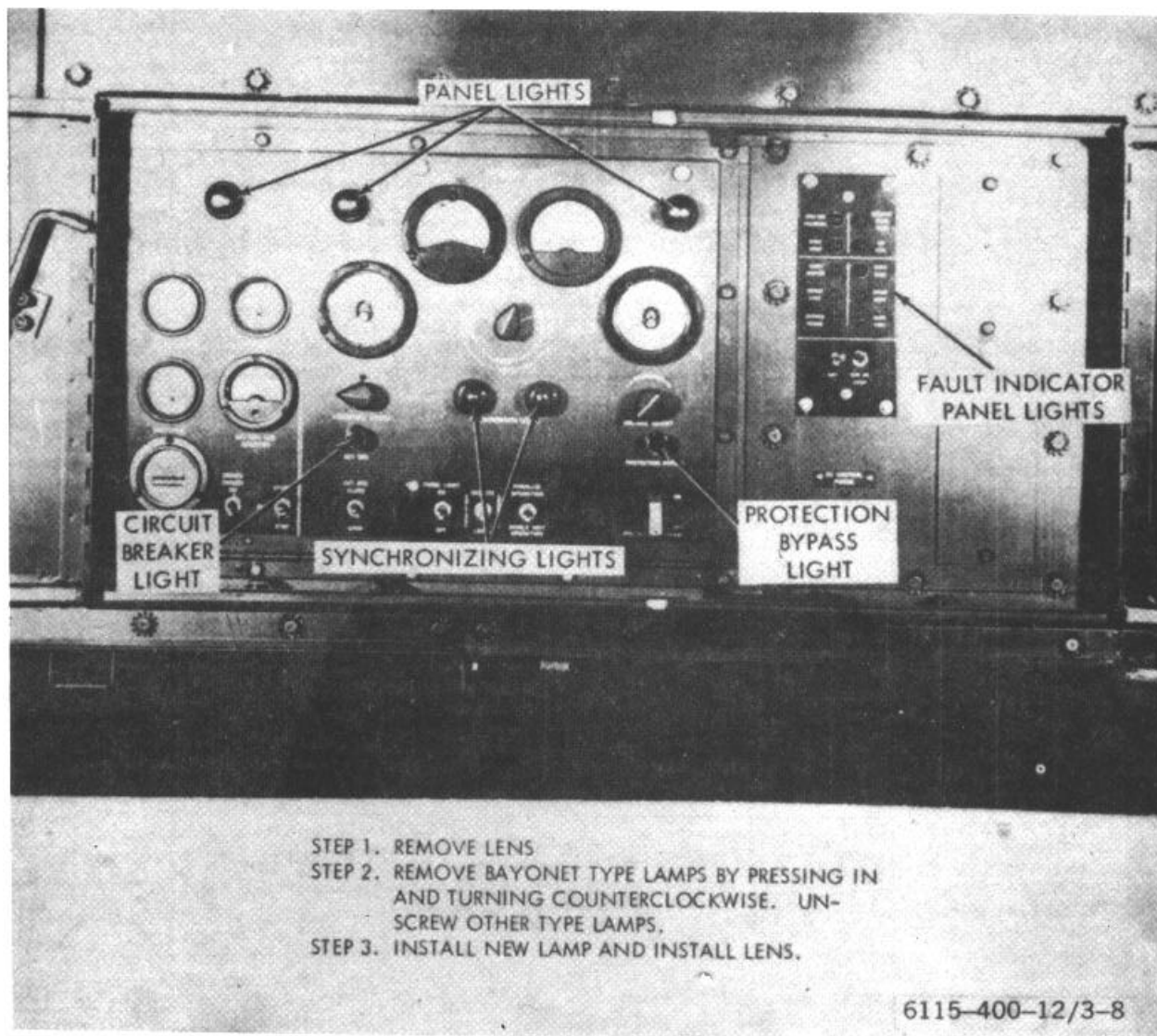
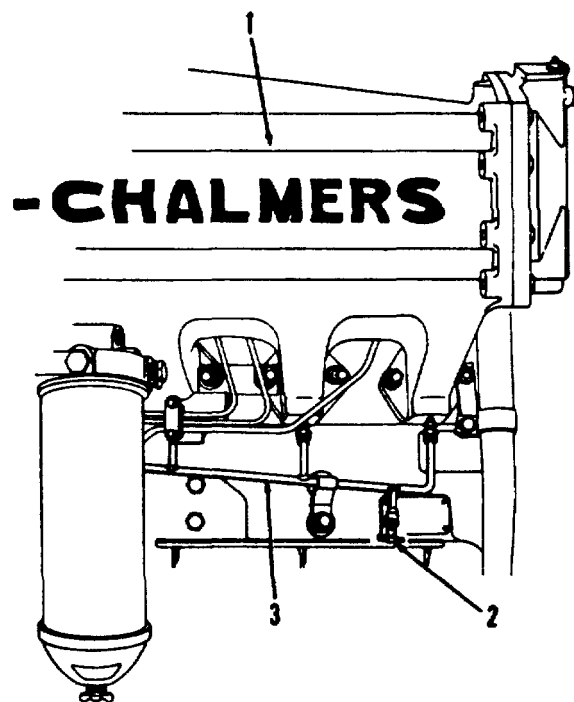

Figure 3-8. Lamp and fuse replacement.



6115-400-12/3-9

- 1. Intercooler and intake manifold
- 2. Drain cock
- 3. Collector manifold

Figure 3-9. Moisture collector manifold drain.

Section V. TROUBLESHOOTING

3-15. General

This section provides information useful in diagnosing unsatisfactory operation or failure of the generator set or its components.

3-16. Troubleshooting Table

Malfunctions which may occur are listed in table 3-3. Each malfunction stated is followed by a list of probable causes of the trouble. The corrective action recommended is described opposite the probable cause.

Table 3-3. Troubleshooting

Malfunction	Probable cause	Corrective action
1. Engine will not turn	<ul style="list-style-type: none"> a. Batteries weak. b. Starter or starter solenoid switch inoperative. 	<ul style="list-style-type: none"> a. Recharge or replace batteries (para 3-62). b. Repair or replace starter or starter solenoid switch (para 3-56).
2. Engine hard to start	<ul style="list-style-type: none"> c. Engine is locked or seized. a. Batteries weak. b. Incorrect grade of fuel. 	<ul style="list-style-type: none"> c. Refer to higher echeon a. Recharge or replace batteries (para 3-62). b. Drain fuel system. Fill the tank with the specified fuel. Refer to Appendix B.

Table 3-3. Troubleshooting-Continued

Malfunction	Probable cause	Corrective action
3. Engine stops	<ul style="list-style-type: none"> c. Fuel injection nozzles not operating properly. d. Fuel transfer pump not operating properly. e. Air in fuel system. f. Insufficient air supply to cylinders. g. Fuel injection pump improperly timed. h. Valve lash incorrect 	<ul style="list-style-type: none"> c. Replace nozzles (para 3-3). d. Replace fuel transfer pump (para 3-4). e. Correct air leaks in suction side of fuel system. Vent fuel system (para 3-1). f. Clean air system (para 3-8). g. Time fuel injection pump (para 3-32). h. Adjust valve lash (para 3-22).
4. Engine overheats	<ul style="list-style-type: none"> a. Out of fuel b. Restricted fuel supply. c. Broken or loose fuel lines. d. Fuel transfer pump or fuel injection pump inoperative e. Low oil pressure. f. High coolant temperature. g. Shutdown switch defective a. Leak in cooling system b. Radiator core clogged c. Radiator air passages clogged. d. Fan drive belts too loose. e. Thermostats inoperative. f. Engine oil cooler clogged g. Improper engine lubrication. h. Water pump malfunctioning. 	<ul style="list-style-type: none"> a. Fill fuel tank with specified fuel and vent the fuel system (para 3-31). b. Check fuel system (para 3-29). c. Correct or replace affected parts, d. Replace inoperative pump (para 3-32 or 3-34). e. Check oil level. If satisfactory, adjust oil pressure regulating valve (para 3-27) f. Refer to paragraph 3-42. g. Replace switch (para 3-56). a. Correct all leaks and fill cooling system. b. Clean and flush radiator (para 3-45). c. Remove debris from radiator core d. Adjust fan drive belts to proper tension (para 3-11). e. Test the thermostats for proper operation (para 3-47). f. Clean or replace the oil cooler core (para 3-28). g. Check for proper oil pressure. Refer to higher echelon h. Repair or replace the water pump (para 3-48).
5. Engine shows loss of power	<ul style="list-style-type: none"> i. Fuel injection pump improperly timed. a. Insufficient supply of air to cylinders. b. Insufficient supply of fuel to fuel injection nozzles. c. Air in fuel system. d. Clogged fuel filters. e. Improper valve lash. f. Fuel injection pump improperly timed. 	<ul style="list-style-type: none"> i. Time fuel injection pump (para 3-2). a. Clean system (para 3-8). b. Check fuel system (para 3-29). c. Vent fuel system. Check for air leaks on suction side of fuel transfer pump (para 3-34). d. Change filter element (para 3-30). e. Adjust valve lash (para 3-22). f. Time fuel injection pump (para 3-32).

Table 3-3. Troubleshooting--Continued

Malfunction	Probable cause	Corrective action
6. Engine Runs Uneven and Excessive Vibration	<p><i>g.</i> Inoperative fuel injection pump or fuel injection nozzle.</p> <p><i>a.</i> Governor not operating properly.</p> <p><i>b.</i> Fuel supply erratic or insufficient.</p> <p><i>c.</i> Engine operating temperature too low.</p> <p><i>d.</i> Fuel injection pump malfunctions.</p> <p><i>e.</i> Fuel injection nozzle malfunctions.</p>	<p><i>g.</i> Repair or replace affected parts (paras 3-32 and 3-33).</p> <p><i>a.</i> Refer to higher echelon.</p> <p><i>b.</i> Check fuel stem (para 3-29).</p> <p><i>c.</i> Check thermostats (para 3-47).</p> <p><i>d.</i> Replace fuel injection pump (para 3-32).</p> <p><i>e.</i> Replace nozzle (para 3-33).</p>
7. Engine detonates	<p><i>a.</i> A hard metallic knock indicates detonation in one or more cylinders, the engine must be stopped immediately to prevent serious damage due to the excessive pressures accompanying the detonation. Detonation is caused by the presence of fuel or lubricating oil in the charge of air that has been delivered to the cylinder during the compression stroke.</p>	<p><i>a.</i> Check for leaky fuel injection nozzles or improper timing of fuel injection pump (para 3-32).</p>
8. Engine emits black smoke from exhaust	<p><i>a.</i> Air system clogged.</p> <p><i>b.</i> Improper fuel.</p>	<p><i>a.</i> Check engine air intake system (para 3-8).</p> <p><i>b.</i> Drain fuel system and refill with fuel of proper specification</p>
9. Engine emits blue	<p><i>a.</i> Engine operating temperature too low.</p> <p><i>b.</i> Fuel injection nozzles not operating properly.</p>	<p><i>a.</i> Check thermostat (para 3-47).</p> <p><i>b.</i> Replace nozzles (para 3-33).</p>
10. Starter will not crank engine	<p><i>a.</i> Batteries weak.</p> <p><i>b.</i> Cables bad/or connections loose or corroded.</p> <p><i>c.</i> Starter solenoid switch inoperative</p> <p><i>d.</i> Starter brushes worn or not contacting properly.</p> <p><i>e.</i> DC control circuit breaker in OFF position.</p>	<p><i>a.</i> Check batteries (para 3.62).</p> <p><i>b.</i> Tighten all loose connections and clean corrosion from all terminals.</p> <p><i>c.</i> Replace solenoid switch (para 3-56).</p> <p><i>d.</i> Install new brushes or fit brushes to conform to contour of commutator (para 3-82).</p> <p><i>e.</i> Push DC control circuit breaker to ON position (para 2-10).</p>
11. Starter pinion will not engage flywheel gear	<p>Grease and/or dirt in start mechanism.</p>	<p>Refer to direct and general support maintenance</p>
12. Low oil pressure	<p><i>a.</i> Oil pressure relief valve or regulator valve stuck in open position.</p> <p><i>b.</i> Improper lubricant.</p>	<p><i>a.</i> Clean, replace affected part (paras 3-26 and 3-27).</p> <p><i>b.</i> Fill crankcase with specified lubricant.</p>
13. Excessive oil pressure	<p><i>a.</i> Oil pressure regulating valve improperly adjusted.</p> <p><i>b.</i> Improper lubricant.</p>	<p><i>a.</i> Adjust valve to obtain proper pressure (para 3-27).</p> <p><i>b.</i> Drain and fill crankcase with specified lubricant.</p>

Table 3-3. Troubleshooting Continued

Malfunction	Probable cause	Corrective action
14. Lubricating oil overheats	<ul style="list-style-type: none"> a. Insufficient oil in crankcase. b. Improper lubricant. c. Engine oil cooler clogged. 	<ul style="list-style-type: none"> a. Fill crankcase to proper level. b. Drain and fill crankcase with specified lubricant. c. Clean or replace the oil cooler (para 3-28).
15. Batteries will not hold charge	<ul style="list-style-type: none"> a. Loose terminals or connections. b. Short in electrical system. c. Defective battery. d. Generator regulator not operating properly. 	<ul style="list-style-type: none"> a. Check and tighten. b. Check cables and wiring. c. Replace defective battery (para 3-62). d. Refer to paragraph 3-58.
16. Main generator fails to build up to rated voltage or output voltage too low	<ul style="list-style-type: none"> a. Voltage not adjusted to the selected operating voltage. b. Improper generator peating procedure. c. Loose terminal connections on voltage reconnection panel. 	<ul style="list-style-type: none"> a. Adjust voltage control rheostat (fig. 2-9) to agree with b. Refer to para 2-11 for applicable operating details. c. Stop the engine (para 2-12), and tighten all connections at voltage reconnection panel (fig. 2-5).
17. Voltage drops under load	<ul style="list-style-type: none"> d. Brushes defective. a. Brushes defective. 	<ul style="list-style-type: none"> d. Replace brushes (para 3-82). a. Replace brushes (para 3-82).
18. Main generator overheats	<ul style="list-style-type: none"> b. Unit paralleling switch defective. a. Generator louver doors Closed. b. Generator ventilating louvers or screens obstructed. c. Operating area not adequately ventilated. d. Generator overloaded. 	<ul style="list-style-type: none"> b. Replace unit paralleling switch (para 3-65). a. Open louver doors. b. Remove obstructions from louvers and screens. c. Increase ventilation in the operating area. d. Reduce the load and report the condition to righer echelon.
19. Main Generator Fails to Supply Power to Load	<ul style="list-style-type: none"> a. Circuit breaker is in OFF position. 	<ul style="list-style-type: none"> a. Throw circuit breaker to ON position at proper time (figs. 2-9 and 2-110).
<p>Warning: Make sure unit is shut down before performing work on load cables or load terminal.</p>		
	<ul style="list-style-type: none"> b. load cables not connected correctly. c. Load cables defective d. Load terminal studs defective or loose. 	<ul style="list-style-type: none"> b. Reconnect load cables correctly (para 2-5). c. Replace the load cables. d. Clean and tighten load terminal studs (para 2-5) or replace studs.
20. Generator fails to maintain KW load division during parallel operation	<ul style="list-style-type: none"> a. Generator frequency fluctuates or drifts. b. Generator frequency drops under load. c. Unit-parallel switch not in PARALLEL position. d. Paralleling cable not securely connected. 	<ul style="list-style-type: none"> a. Refer to paragraph 2-14. b. Refer to paragraph 2-14. c. Place unit-parallel switch in PARALLEL position (fig. 2-10). d. Reconnect paralleling cable securely.

Table 3-3. Troubleshooting-Continued

Malfunction	Probable cause	Corrective action
21. Voltage output too high 22. Main generator noisy	a. Improper voltage adjustment b. Remote voltage control circuit is not complete when single-unit remote operation is required a. Foreign object penetrating the generator ventilating louvers or screens.	a. Refer to paragraph 2-14 for applicable operating details and adjust voltage to agree with position of voltage reconnection panel (fig. 2-5). b. Make sure the remote voltage control circuit is complete. a. Remove object from louvers or screens.
<p>Caution: Unusual noises from the generator generally indicate a part failure. Stop the generator set immediately (fig. 2-8) as continued operation may result in additional damage to the generator. Report unusual noise to higher echelon.</p>		
23. AC ammeter fails to register	a. Ammeter defective. b. Ammeter-voltmeter selector switch defective.	a. Replace ammeter (para 3-68). b. Replace selector switch (para 3-70).
24. Generator frequency drops under load	a. Engine lacks power.	a. Check timing cycle of engine.
25. Generator fails to parallel	a. Unit parallel switch defective.	a. Replace unit parallel switch (para 3-73).
26. Voltage erratic	b. Paralleling receptacle defective.	b. Replace paralleling receptacle.
27. Generator sparks at collector rings	a. Brush holders loose b. Brushes faulty. c. Reconnection panel terminals loose.	a. Refer to higher echelon b. Reseat or replace brushes (para 3-82). c. Tighten reconnection panel terminal Replace brush
<p>Warning: Be sure unit is shut down before performing work on reconnection panel.</p>		

Section VI. RADIO INTERFERENCE SUPPRESSION

3-17. Definitions

a. *Interference.* The term "interference" as used herein, applies to electrical disturbances in the radio frequency range which are generated by the generator set and which may interfere with the proper operation of radio receivers or other electronic equipment.

b. *Interference Suppression.* The term "interference suppression" used herein, applies to the methods used to eliminate or effectively reduce radio interference generated by the generator set.

3-18. General Methods Used To Attain Proper Suppression

Essentially, Suppression is attained by providing a low resistance path to ground for

the stray currents. The methods used include shielding the high-frequency wires, grounding the frame with bonding straps, and using capacitors and resistors.

3-19. Interference Suppression Components

a. *Primary Suppression Components.* The primary suppression components are those whose primary function is to suppress radio interference. These components are described and located in figure 3-10.

b. *Secondary Suppression Components.* These components have radio interference suppression functions which are incidental and/ or secondary to their primary function.

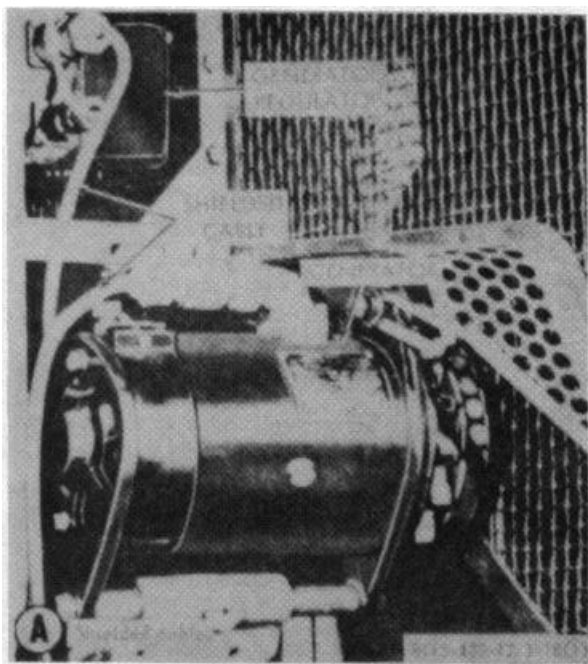

Figure 3-10 (1). Radio interference suppression components.

3-20. Replacement of Suppression Components

Refer to figure 3-10 and replace the radio interference suppression components.

3-21. Testing of Radio Interference Suppression Components

Test the capacitors for leaks and shorts on a capacitor tester; replace defective capacitors. If test equipment is not available and interference is indicated, isolate the cause of interference by the trial-and-error method of replacing each capacitor in turn until the cause of interference is located and eliminated.

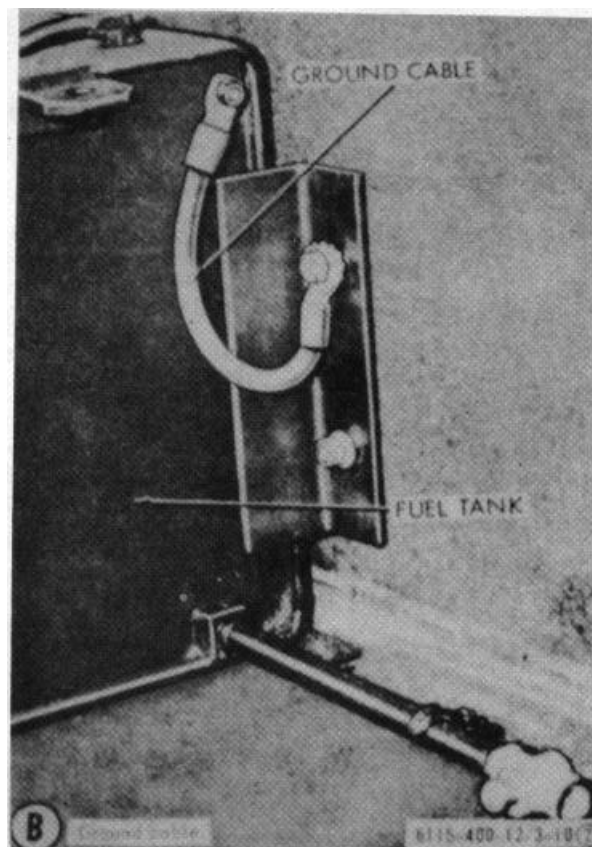

Ground cable.
Figure 3-10 (2). Continued.

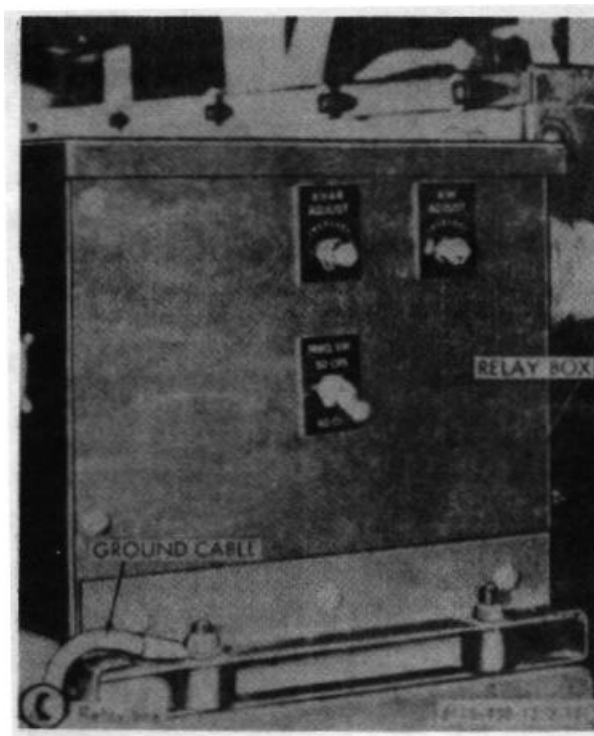

Relay.
Figure 3-10 (3). Continued.

Section VII. ENGINE VALVE MECHANISM

3-22. General

Insufficient valve clearance can cause loss of compression, misfiring, and will eventually cause burning of the valves and valve seats. Excessive valve clearance will result in faulty engine operation, valve lifter noise, and rapid wear of the valve operating mechanism.

With the engine at normal operating temperature (180°F. minimum), the specified valve clearance is .015 inch for the intake valves and .020 inches for the exhaust valves. After any mechanical work has been done which would disturb the valve clearance, the intake valves may be set cold at .018 inches and the exhaust valves at .023 inches so the engine may be run and allowed to warm up. After engine has reached normal operating temperature the valve clearance should again be checked. Refer to figure 3-11 for valve location.

Caution: After any mechanical work has been done which would disturb the valve adjustment, make certain that the adjusting screws in the rocker arms are turned upward (counterclockwise) high enough so that the rocker arms and push rods will not open the valves too far and thus allow the pistons to strike the valves when the engine is cranked.

3-23. Valve Clearance Adjustment

The valve lash must be adjusted when piston is near top dead center on its compression stroke and the intake and exhaust valves closed. No. 1 and No. 6 pistons move up and down in their respective cylinders simultaneously and when one piston is on its compression stroke, the other piston is on its exhaust stroke, and vice versa. Observe valves for No. 6 cylinder; when exhaust valves are nearly closed and intake valves start to open, the

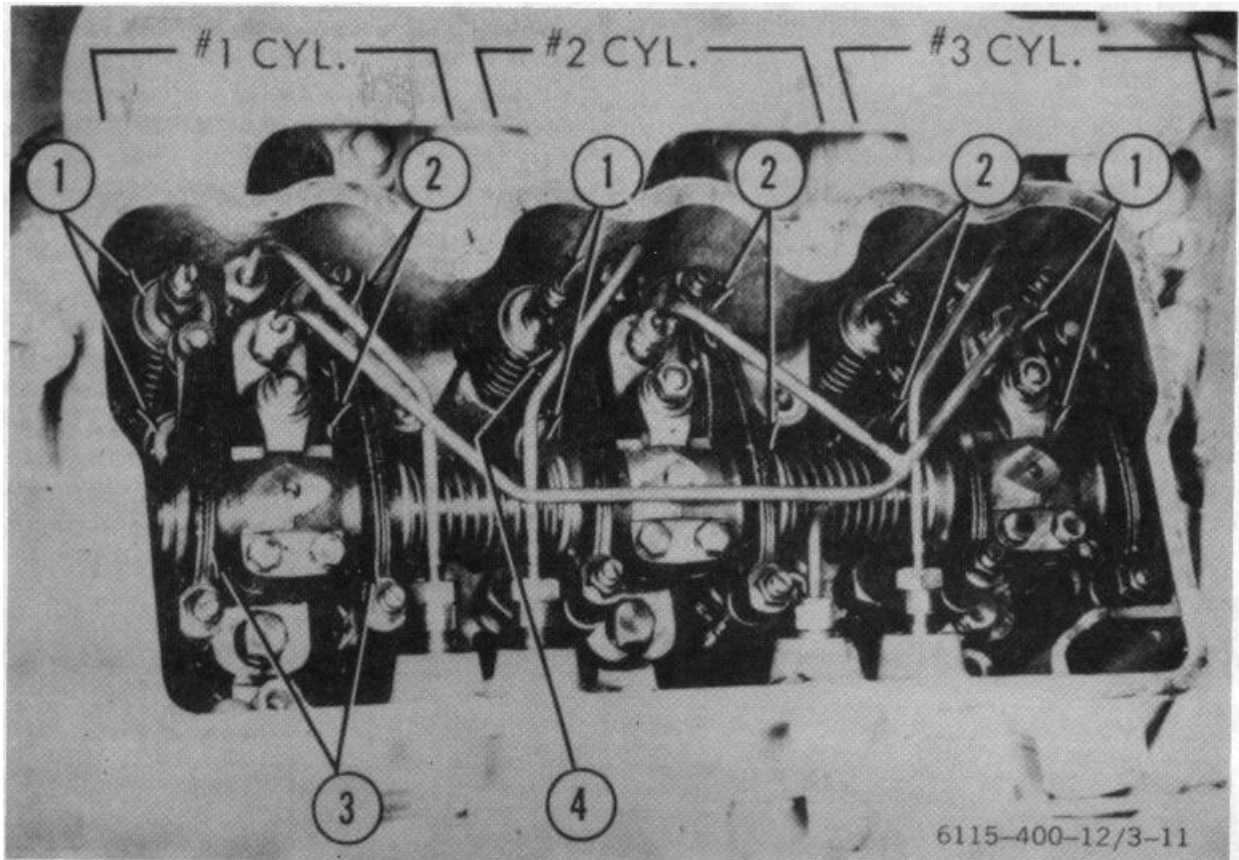

Figure 3-11. Rocker arm and valve location

No. 6 piston is near top dead center on its exhaust stroke and the No. 1 piston is in the same position on its compression stroke, therefore, all four valves for No. 1 cylinder are closed and lash may be adjusted. The firing order of engine is 1-5-3-6-2-4 and if this sequence is followed, the last for all valves can be checked and adjusted in two complete revolutions of crankshaft. When adjustment is necessary, proceed as follows to obtain the specified clearance:

a. Operate the engine until it reaches 180°F. minimum. Stop the engine.

b. Thoroughly clean the valve rocker covers and surrounding area.

c. Remove the valve rocker cover capscrews, rocker cover sealing washers and the rocker covers.

d. Use barring tool (fig. 3-12 (1)) to turn engine until exhaust valves for No. 6 cylinder

are nearly closed and intake valves start to open, then check and adjust valve clearance for No. 1 cylinder.

Note. The dual intake and exhaust valves for each cylinder are actuated by valve bridges. The valve bridge **MUST** be adjusted first (before adjusting valve lash) to assure that each valve bridge contact both valves simultaneously.

e. Adjust each valve bridge by loosening locknut on the bridge adjusting screw; then turn the screw upward (counterclockwise) approximately one turn.

f. Hold down firmly on center of bridge with the fingers of one hand and turn bridge adjusting screw downward (clockwise) until screw just contacts the valve stem. Hold screw stationary and tighten locknut securely (fig. 3-12 (2)).

g. Adjust for proper lash by loosening the jam nut on each rocker arm adjusting screw (fig. 3-13).

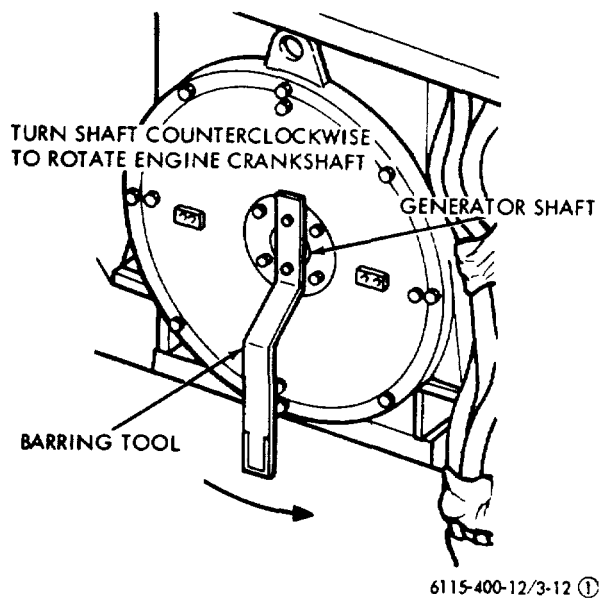

h. Turn each adjusting screw downward (clockwise) as necessary to increase clearance between rocker arm and valve bridge. The clearance (lash) is properly set when a feeler gage (.015" for intake valves, .020" for exhaust) passes, with a slight drag, between the rocker arm and valve bridge.

i. Hold adjusting screw stationary and tighten locknut. Recheck the clearance to make certain it did not change.

j. Adjust valves for other cylinders in firing order sequence.

Figure 3-12 (1). Adjusting valve bridge.

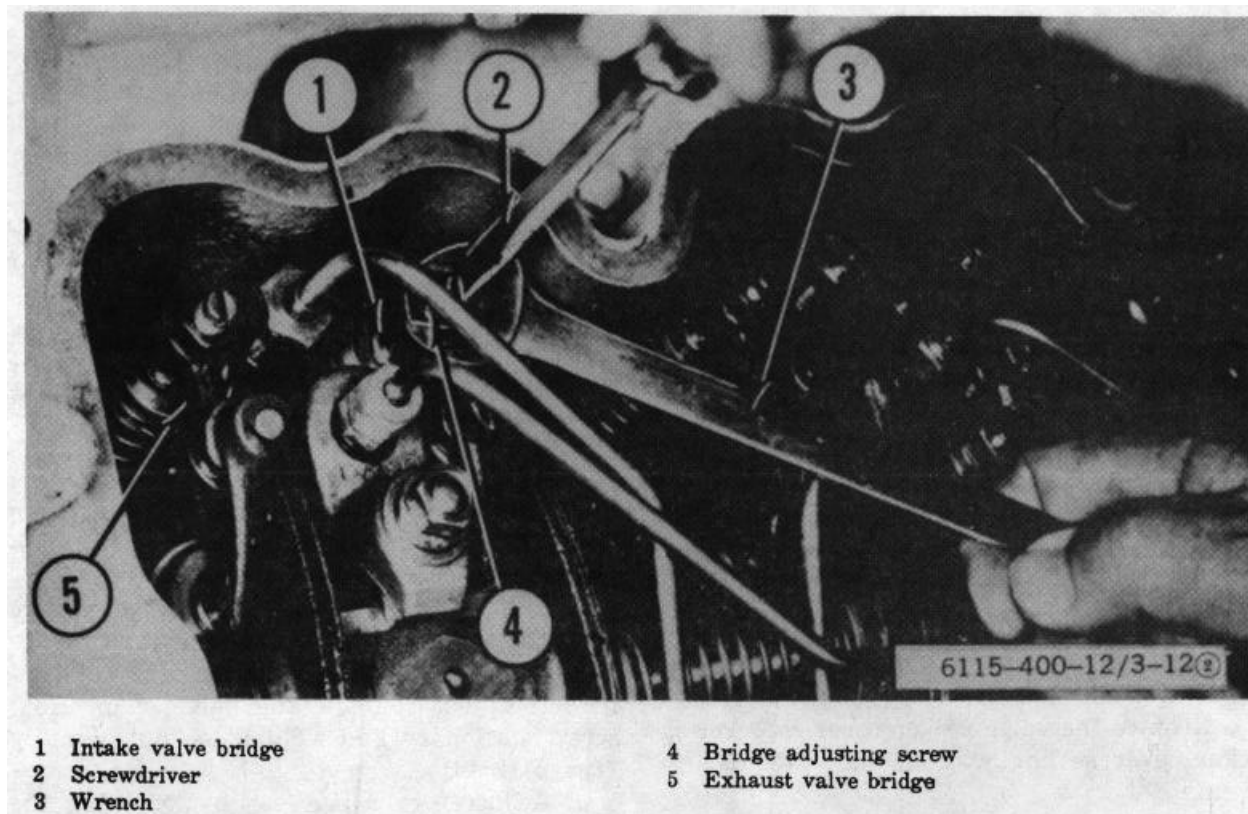

Figure 3-12 (2). Continued.

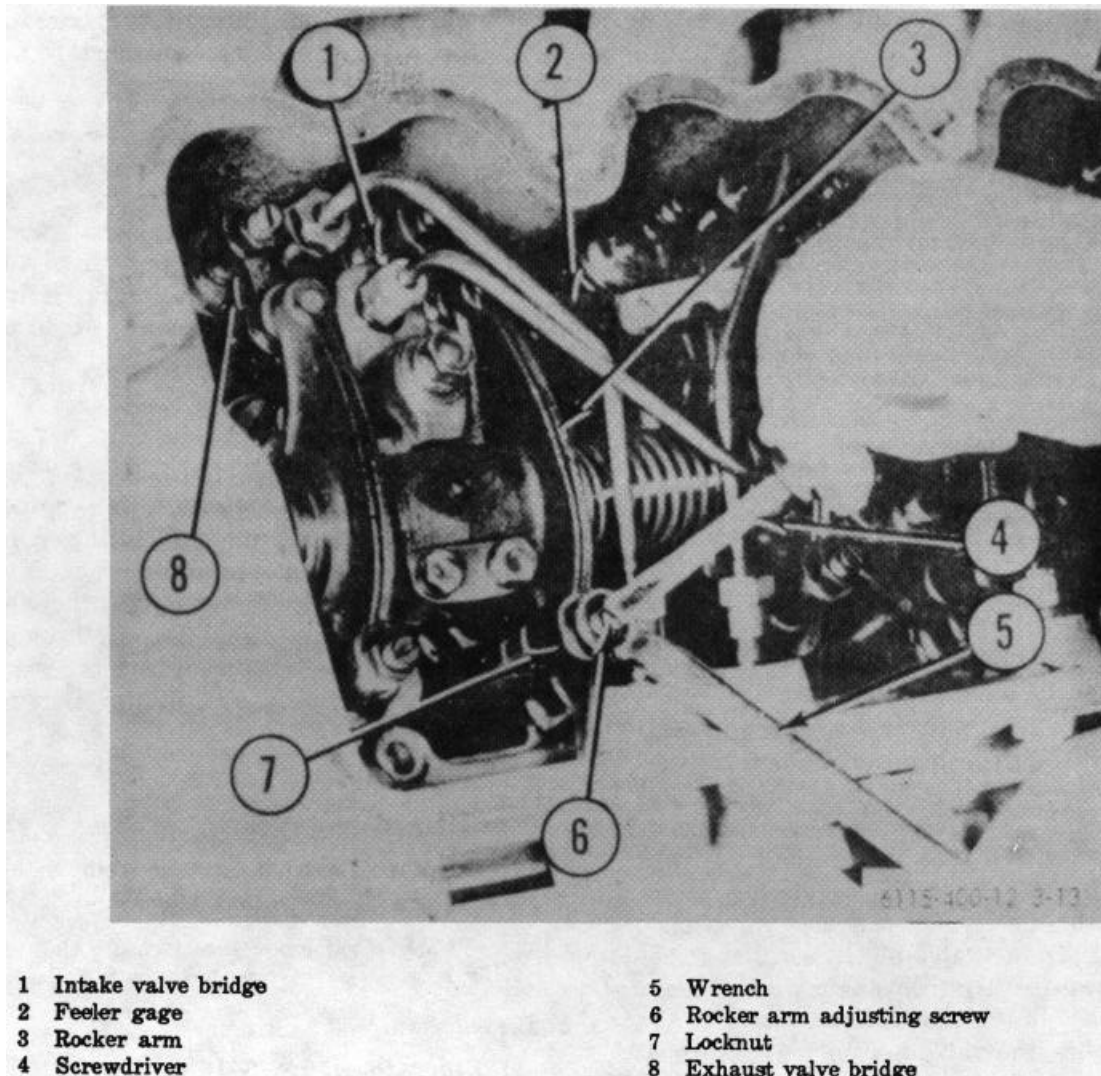

Figure 3-13. Adjusting valve clearance.

Section VIII. ENGINE LUBRICATION SYSTEM

3-24. General

The engine is pressure-lubricated throughout by a gear-type lubricating oil pressure pump, driven by the oil pump driving gear in mesh with the crankshaft gear located on the front end of the crankshaft. The engine oil pressure should be between 30 and 60 psi when the engine is operating at full throttle and with the engine coolant at normal operating temperature. The lubrication system is so designed that the engine can be operated at up to a 15° angle.

3-25. Oil Filters

a. General.

- (1) The engine lubricating oil filters are of the full-flow type and contain replaceable elements. A drain-plug in each filter shell permits draining of the filters when replacing the filter elements. New elements must be installed each time the oil pan lubricant is changed, or more often if conditions warrant.

- (2) A bypass (pressure relief) valve, located in the oil filter head permits oil to pass directly to the main oil gallery if the oil filters become clogged, or when in cold weather the oil is too thick to flow freely through the filters.

b. Removal and Disassembly. Refer to figure 3-14 for removal and disassembly of the oil filters.

c. Reassembly and Installation. Refer to figure 3-14 to reassemble and install the oil filters.

3-26. Oil Filter Relief Valve

Each 3,000 hours of operation, remove, clean, and inspect the parts of the oil filter relief valve (fig. 3-14). When piston or inside diameter of the sleeve shows excessive wear, the parts must be replaced.

3-27. Oil Pressure Regulating Valve

a. General. The oil pressure regulating valve is located in the main oil gallery at the right-front corner of the cylinder block. The pressure regulating valve maintains stabilized oil pressure within the lubrication system. When the oil pressure at the regulating valve exceeds approximately 55 psi, the valve piston is raised off the valve piston seat, and the oil is bypassed directly from the cylinder block to the oil pan. If the lubrication system is allowed to sludge, the valve may not work properly. If the valve sticks in the open position, a sharp drop in the engine oil pressure will occur; if the valve sticks in the closed position, a sharp rise in the engine oil pressure will occur.

b. Removal. Every 300 hours of operation, remove and inspect the oil pressure regulating valve. Remove pressure regulating valve screw, noting the number of turns required for removal. Withdraw the valve spring and piston.

c. Installation.

- (1) Thoroughly clean the area in the cylinder block, lubricate the valve piston

with clean oil (the valve piston must slide smoothly in the bore of the cylinder block), and install the regulating valve components.

Note. Turn the valve screw into the cylinder block the same number of turns that was required for removal.

- (2) Start engine and allow it to reach normal operating temperature. Adjust the oil pressure regulating valve screw to obtain oil pressure of 40 to 50 psi at rated engine speed.

3-28. Oil Cooler

a. General. The engine oil cooler (fig. 16), located on the right side of the engine, consists of a corrosion resistant cooling core and tank. The water pump circulates coolant through the cooling core tubes and the engine oil pressure pump circulates oil through the tank, around the outside of the tubes of the cooling core, thereby controlling oil temperature.

b. Removal.

- (1) Drain cooling system.
- (2) Refer to figure 3-16 and remove oil cooler.

Note. If oil cooler a is badly clogged, a new oil cooler core must be installed.

c. Installation.

- (1) Refer to figure 3-16 and install oil cooler in reverse order of removal. Use new gaskets and performed packings.
- (2) Fill cooling system.
- (3) Operate the engine and check for oil and water leaks at the oil cooler connections. Correct any leaks found. Stop engine and check crankcase oil level in oil pan; add oil as necessary to raise oil level to the full mark on oil level gage (dipstick). Check coolant level and add coolant if necessary.

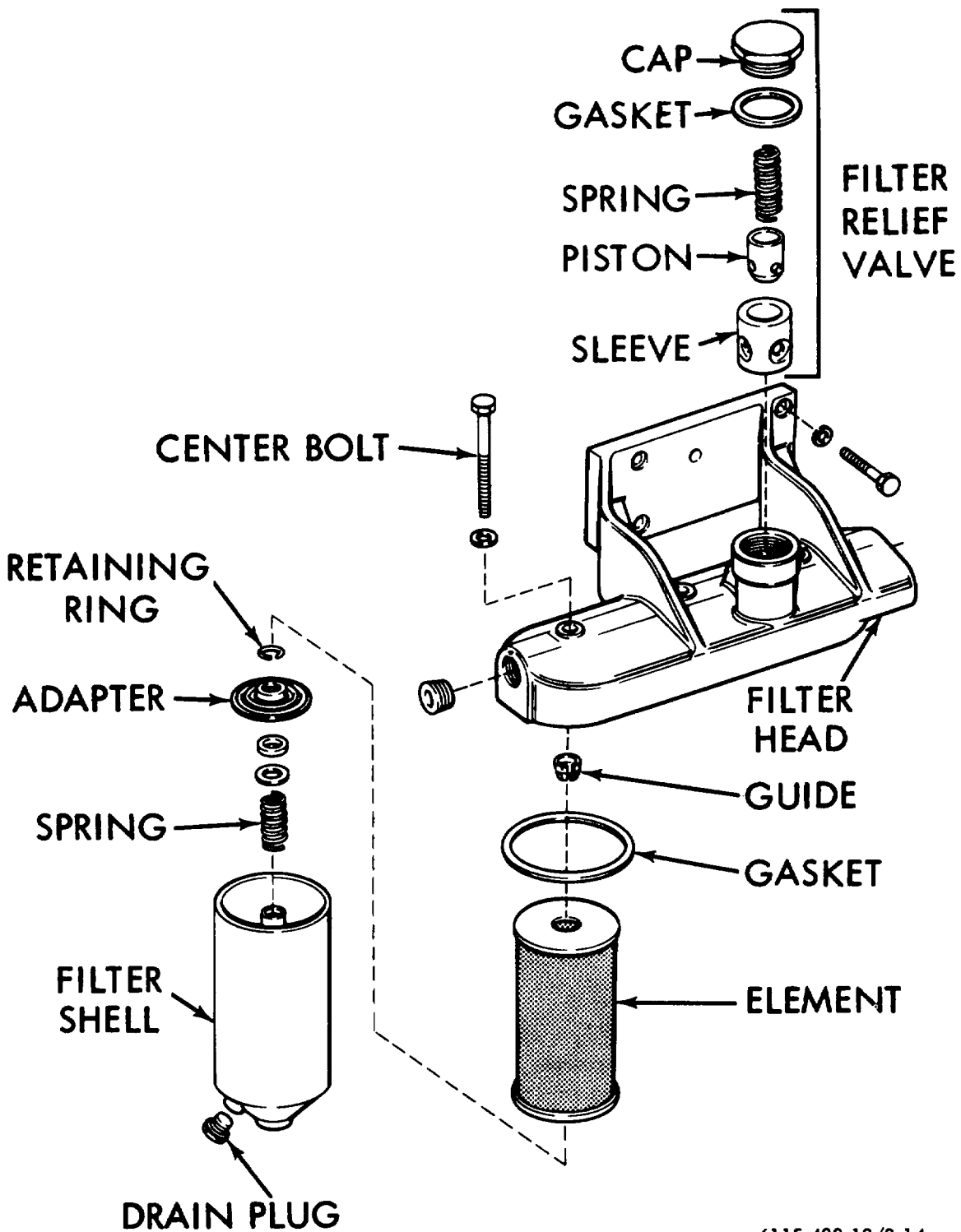

6115-400-12/3-14

Figure 3-14. Oil filters, removal, disassembly, reassembly, and installation.

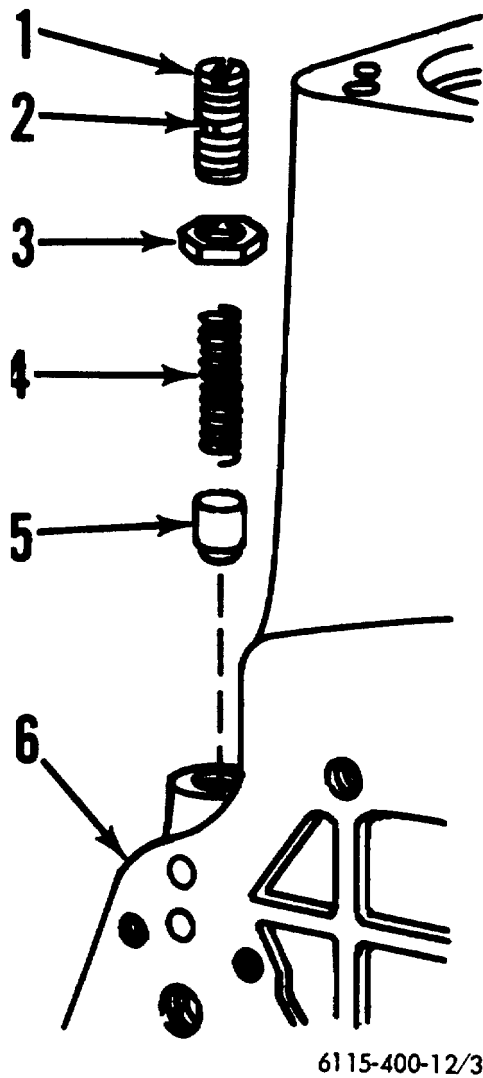

- | | |
|----------------|------------------|
| 1 Screw | 4 Spring |
| 2 Nylon Pellet | 5 Piston |
| 3 Jam nut | 6 Cylinder block |

Figure 3-15. Oil pressure regulator valve, removal and installation.

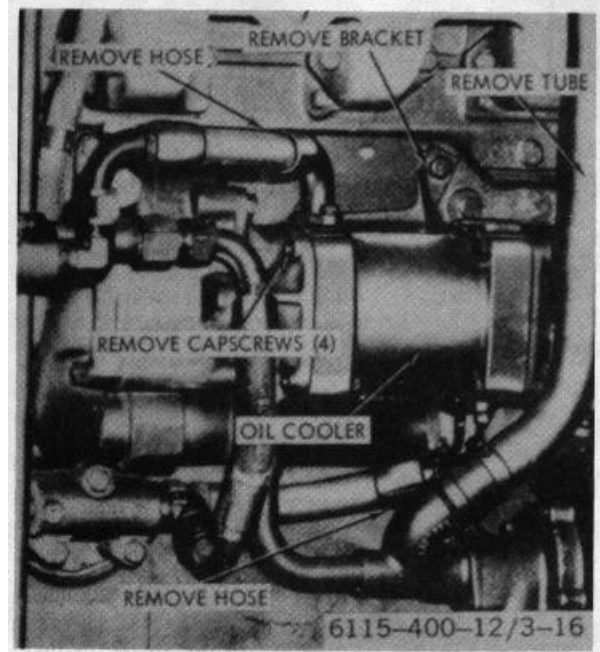

Figure 3-16. Oil cooler, removal and installation.

Section IX. FUEL SYSTEM

3-29. General

a. The engine fuel system (fig. 3-17) consists of two fuel pressure systems; the low pressure system, and the high pressure system.

b. In the low pressure system, fuel is drawn from the fuel tank by the electric fuel pumps and forced through the primary fuel strainer F1 and fuel filter F3 to the day tank. Fuel flows by gravity from the day tank to the

transfer pump and is then forced through fuel filter F2 to the fuel injection pump.

c. In the high pressure system, the fuel injection pump picks up fuel from the gallery, meters and forces the fuel, under extremely high pressure, to the fuel injection nozzles. The nozzles spray the fuel into the engine combustion chambers. The fuel injection lines are seamless steel tubing and each line is the same length. These lines being of equal length assures proper timing and the proper amount of fuel to each injection nozzle.

3-30. Fuel Strainer and Filters

a. *General.* The fuel strainer and filter head (fig. 3-18) is a manifold used to collect and distribute fuel; the head also serves as a holder for the F1 and F2 elements and shells. The head for filter F3 is illustrated in figures 3-18(2) and 3-5(2). Inspect heads for cleanliness at time of changing filter elements.

b. *Filter and Strainer Service.* Open the drain cock in the bottom of each shell before start of daily operations in warm weather or shortly after the end of daily operations in freezing weather. Allow any water or sediment to drain. Close the drain cocks as soon as clean fuel runs out. Remove and discard the filter elements F2 and F3 and install new elements after every 500 hours of operation. Clean F1 strainer element every 500 hours. Clogged fuel filters are usually indicated by irregular engine performance. Vent fuel system after replacing filter elements and cleaning strainer element.

3-31. Venting Fuel System

a. Day Tank to Fuel Injection Pump. (figs. 3-17 and 3-18).

- (1) Close DC control circuit breaker.
- (2) Place engine switch in RUN position.
- (3) Place protection bypass switch in ON position.
- (4) Loosen second stage fuel filter F2 vent screw.
- (5) Push starter switch to rotate engine until a full stream of fuel flows from around the vent screw free of bubbles.

Caution: Do not use starting motor continuously for more than 30 seconds. After 30 seconds of use, pause two minutes to allow motor to cool.

- (6) Tighten vent screw of second stage filter F2 while continuing to rotate engine.

b. *Bleeding Fuel Injection Pump Gallery.* To bleed the pump gallery, disconnect the fuel line from the overflow valve (fig. 3-20) and rotate engine. Continue until fuel oil free of bubbles flows from overflow valve. Reconnect fuel line to overflow valve (fig. 3-20).

c. *Venting High Pressure System.*

- (1) The high pressure fuel system is usually self-venting due to the fact that any air trapped by the fuel injection pump plungers is forced out through the fuel injection nozzles and into the engine combustion chambers. However, in the event the fuel lines have been removed, the engine has run out of fuel, or the engine has not been operated for some time, venting of the high pressure system may be necessary to facilitate engine starting.
- (2) Vent the high pressure fuel system as follows:
 - (a) Loosen connector nut attaching the upper end of each fuel injection line to its corresponding fuel line connector in the rocker cover housing.
 - (b) Crank engine with the starter until fuel flows from ends of all fuel injection lines. Tighten fuel line connector nuts.

Caution: Do not use starting motor continuously for more than 30 seconds. After 30 seconds of use pause two minutes to allow motor to cool.

3-32. Fuel Injection Pump

a. Removal. (Refer to fig. 3-19 and 3-20.)

- (1) Remove governor actuator with hoses attached.

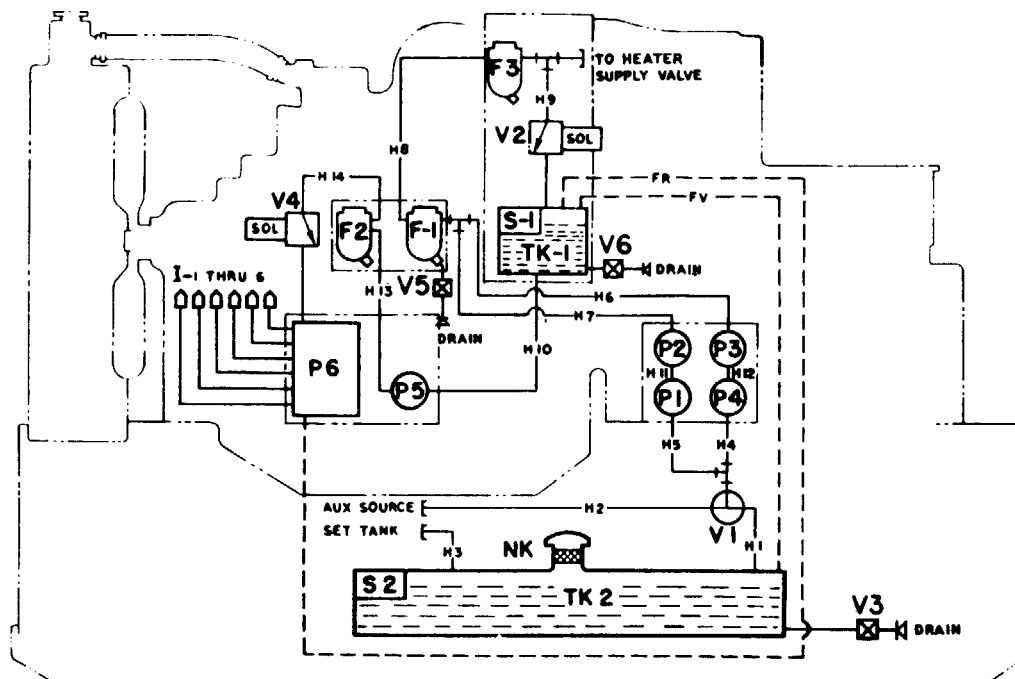

COMPONENT PARTS		
SYM	PART NO.	DESCRIPTION/LOCATION
F1	REFERENCE	STRAINER, FUEL, PRIMARY/BASIC ENGINE
F2	REFERENCE	FILTER, FUEL, SECONDARY/BASIC ENGINE
F3	D13214E7377	FILTER, FUEL, SECONDARY
FR	MS18036-8-0121	HOSE ASSEMBLY, OVERFLOW (TK1 TO P6)
FV	MS18036-6-0442	HOSE ASSEMBLY, VENT (TK1 TO TK2)
H1	MS18036-8-0311	HOSE ASSEMBLY, FUEL (TK2 TO V1)
H2	MS18036-8-0161	HOSE ASSEMBLY, FUEL (V1 TO AUX SOURCE)
H3	MS18036-8-0231	HOSE ASSEMBLY, FUEL (TK2 TO SET TANK)
H4	MS18036-8-0101	HOSE ASSEMBLY, FUEL (V1 TO P4)
H5	MS18036-8-0161	HOSE ASSEMBLY, FUEL (V1 TO P1)
H6	MS18036-8-0311	HOSE ASSEMBLY, FUEL (P1 TO P3)
H7	MS18036-8-0311	HOSE ASSEMBLY, FUEL (P1 TO P2)
H8	MS18036-8-0231	HOSE ASSEMBLY, FUEL (P1 TO F3)
H9	MS18036-8-0091	HOSE ASSEMBLY, FUEL (V2 TO F3)
H10	MS18036-8-0251	HOSE ASSEMBLY, FUEL (TK1 TO P5)
H11	B13214E7424	TUBE CONNECTOR, FUEL PUMP (P1 TO P2)
H12	B13214E7424	TUBE CONNECTOR, FUEL PUMP (P3 TO P4)
H13	REFERENCE	HOSE ASSEMBLY (P2 TO P5)/BSC ENG GR ASSY
H14	REFERENCE	HOSE ASSEMBLY (P2 TO V4)/BSC ENG GR ASSY
I1-6	REFERENCE	NOZZLE AND ROLLER ASST/BSC ENG GR ASSY
NK	D13214E7343	FILLER NECK ASST/FUEL STS OR ASSY
P1-4	MS51321-2	PUMP, FUEL, ELECTRICAL, 24 VDC, 25 GPH CAP
P5	REFERENCE	PUMP, HAND TRANSFER/BSC ENG GR ASSY
P6	REFERENCE	PUMP, FUEL INJECTION/BSC ENG GR ASSY
S1	C13214E7348	SWITCH, FUEL, LEVEL
S2	D13214E7374	TRANSMITTER, GAUGE, FUEL
TK1	D13214E7341	TANK, FUEL, DAY
TK2	D13214E7342	TANK, FUEL, ENGINE
V1	C13214E7451	VALVE, SELECTOR, 3-WAY
V2	C13214E7485	VALVE, FUEL
V3	B13214E7457	VALVE, DRAIN, FUEL
V4	C13214E7485	VALVE, FUEL/BSC ENG GR ASSY
V5	B13214E7426	VALVE, DRAIN, FILTER
V6	B13214E7427	VALVE, DRAIN, DAYTANK

REFERENCE DRAWINGS	
D13214E7330	GENERATOR SET
D13214E7332	BASIC ENGINE GROUP (AC 4388490)

SPECIFICATION DATA	
FUELS: VV-F-800, MIL-J-5628, MIL-P-45121 (SEE FUEL CHART)	
FUEL CONSUMPTION: 15.8 GAL/HR	
SET TANK CAPACITY: 200 U S GALLONS	

6115-400-12/3-17

Figure 3-17. Fuel system diagram.

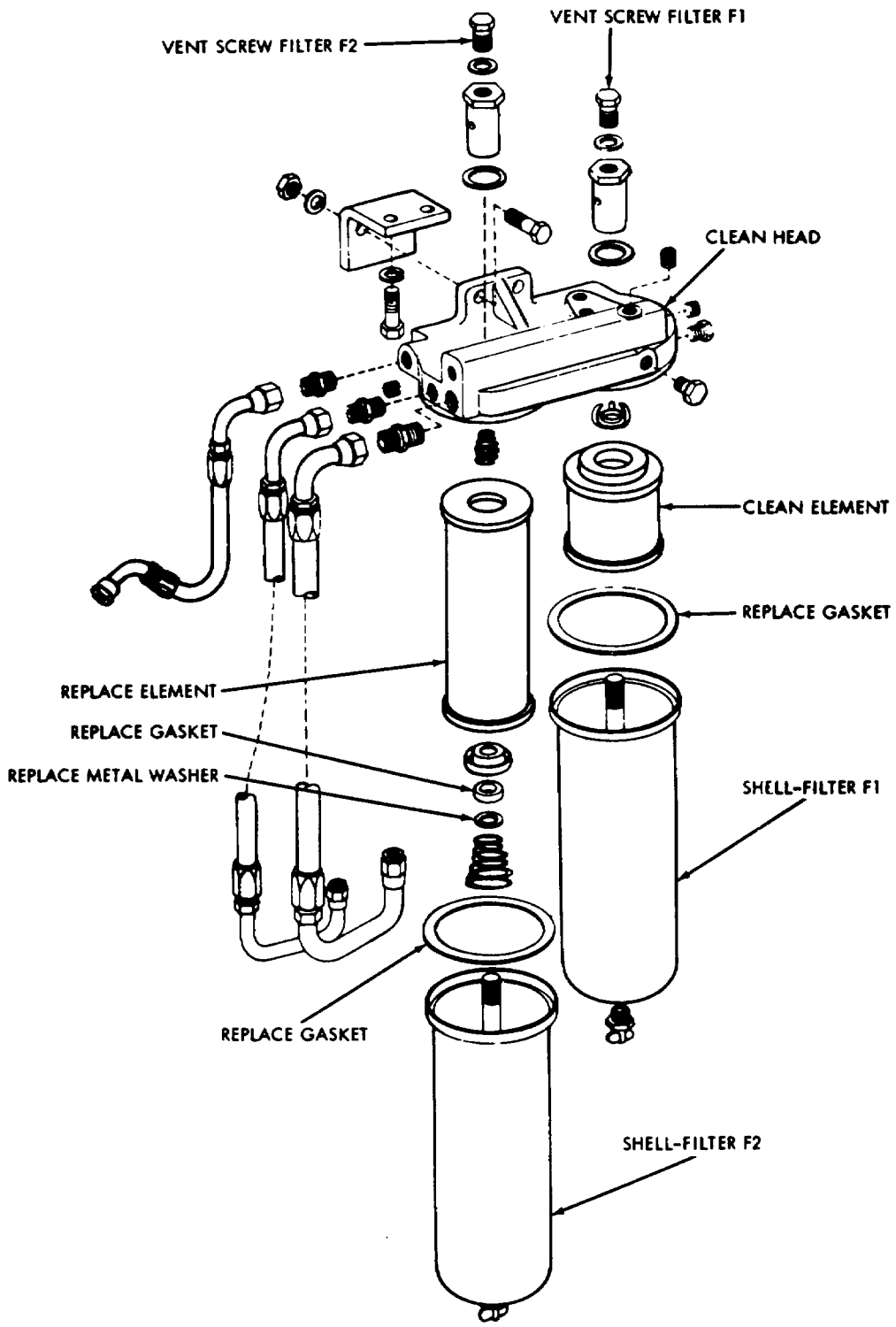

A. FUEL STRAINER F1 AND FILTER F2

6115-400-12/3-18 ①

Figure 3-18 (1). Fuel strainers and filters.

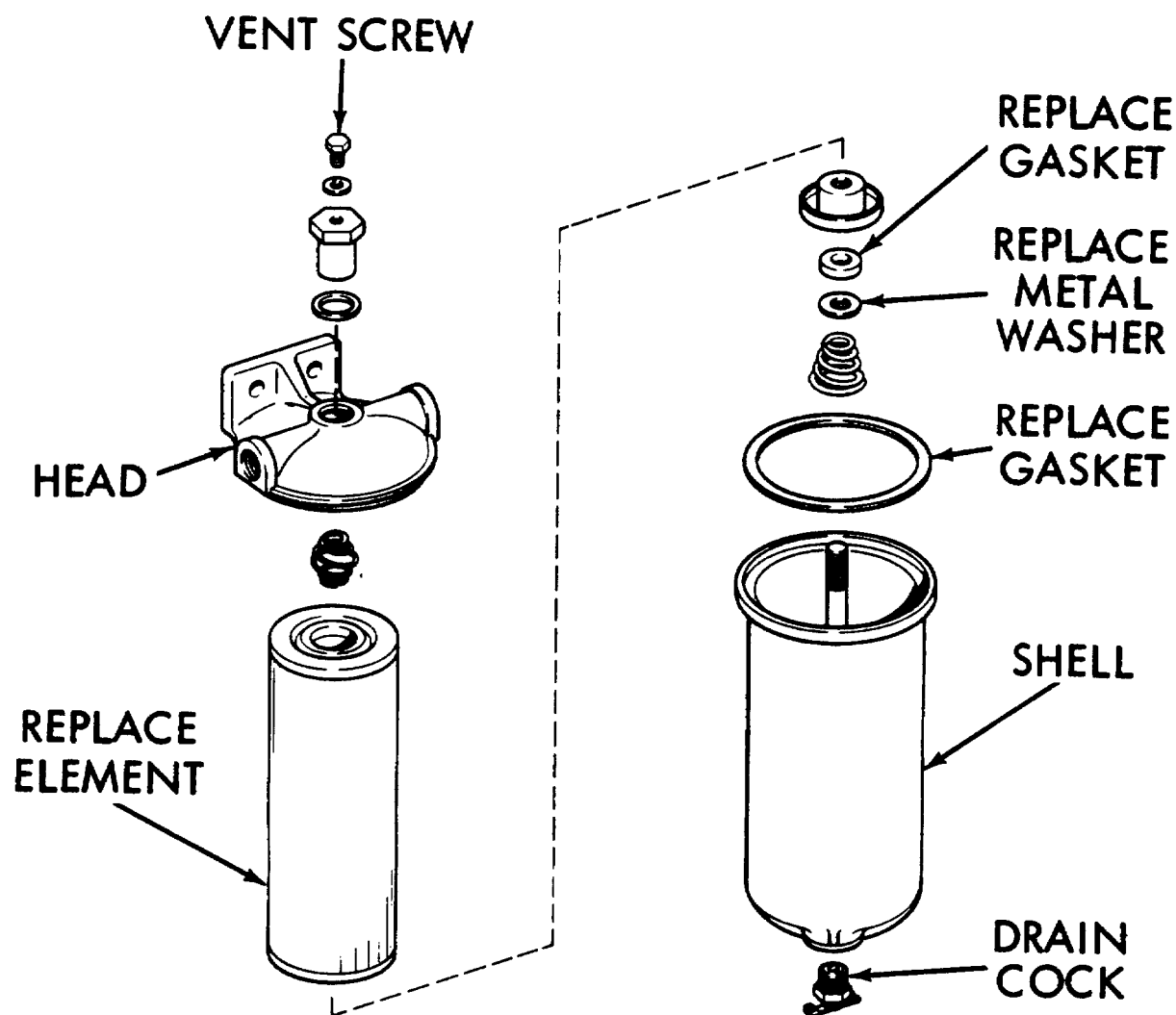

B. FUEL FILTER F3

6115-400-12/3-18 ②

Figure 3-18 (2). Continued.

- (2) Drain day tank (TK-1, fig. 3-17).
- (3) Before removing the pump from the engine, make certain the FPI mark on the coupling hub is aligned with the timing pointer attached to the pump. This will position the No. 1 piston on its compression stroke and facilitate pump installation.
- (4) Disconnect the fuel supply solenoid valve and remove from the fuel injection pump.
- (5) Disconnect the fuel outlet hose and the fuel return and injection lines.
- (6) Disconnect the lubrication hose.
- (7) Remove the capscrews and lockwasher attaching the pump to the pump

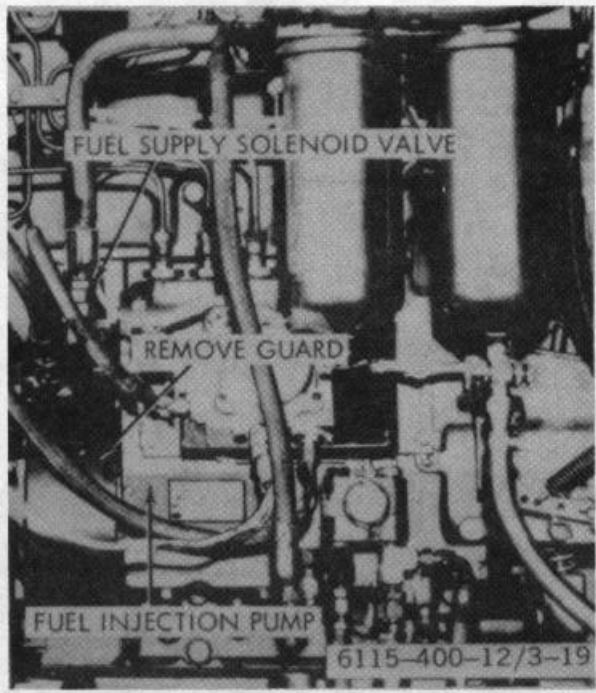

Figure 3-19. Fuel injection pump, removal and installation.

mounting bracket. Raise pump slightly and move it toward the rear, then remove pump and governor as a unit.

b. Installation and Timing.

- (1) Before installing the pump on the engine, make certain the No. 1 piston is on its compression stroke. Refer to figures 3-19, 3-20, 3-21, and 3-22.

Note. To make certain the No. 1 piston (piston nearest fan) is on the compression stroke, remove the cylinder head covers so the valve action can be observed. Use barring lever (fig. 3-14) to turn engine crankshaft until No. 6 cylinder exhaust valves are nearly closed and No. 6 cylinder intake valves are just starting to open. This will position near the top of its compression stroke.

- (2) Remove the timing hole cover (fig. 3-21) from the flywheel housing. Rotate the crankshaft in the normal direction of rotation by using the barring lever (fig. 3-12). Turn the

flywheel until the timing pointer is aligned with 34 degrees BTDC.

Note. To insure that all the slack is out of the engine timing gears and fuel pump drive, never rotate the flywheel backwards if the correct degree mark is passed. Back up several inches and again come up to the correct degree mark in the correct rotation.

- (3) Try the fuel injection pump drive coupling spider on both the drive coupling flange and the coupling hub to see if the spider fits firmly on the coupling members. If the clearance is excessive replace the coupling spider.
- (4) Loosen the two drive coupling capscrews just enough to allow the drive coupling flange to be turned for alignment when the pump is positioned.
- (5) Clean the surfaces and install a new seal in the counterbore of the oil inlet and oil return passages of the fuel injection pump mounting bracket.
- (6) Turn the injection pump coupling hub to align the FPI timing mark on the hub with the timing pointer.
- (7) Install the fuel injection pump and governor in position on the pump mounting bracket. Install spider on hub driving lugs and install flange into the spider. Make certain that the packings and governor oil drain coupling are properly installed between the bottom of the fuel pump and governor, and the pump mounting bracket. Install the capscrew and lockwashers to attach the pump to the mounting bracket. Tighten the capscrews, but not to the extent that the pump cannot be shifted on the mounting bracket by tapping it with a soft-headed hammer.
- (8) At this point the FPI mark on the fuel pump coupling hub should be aligned with the pointer on the fuel pump.

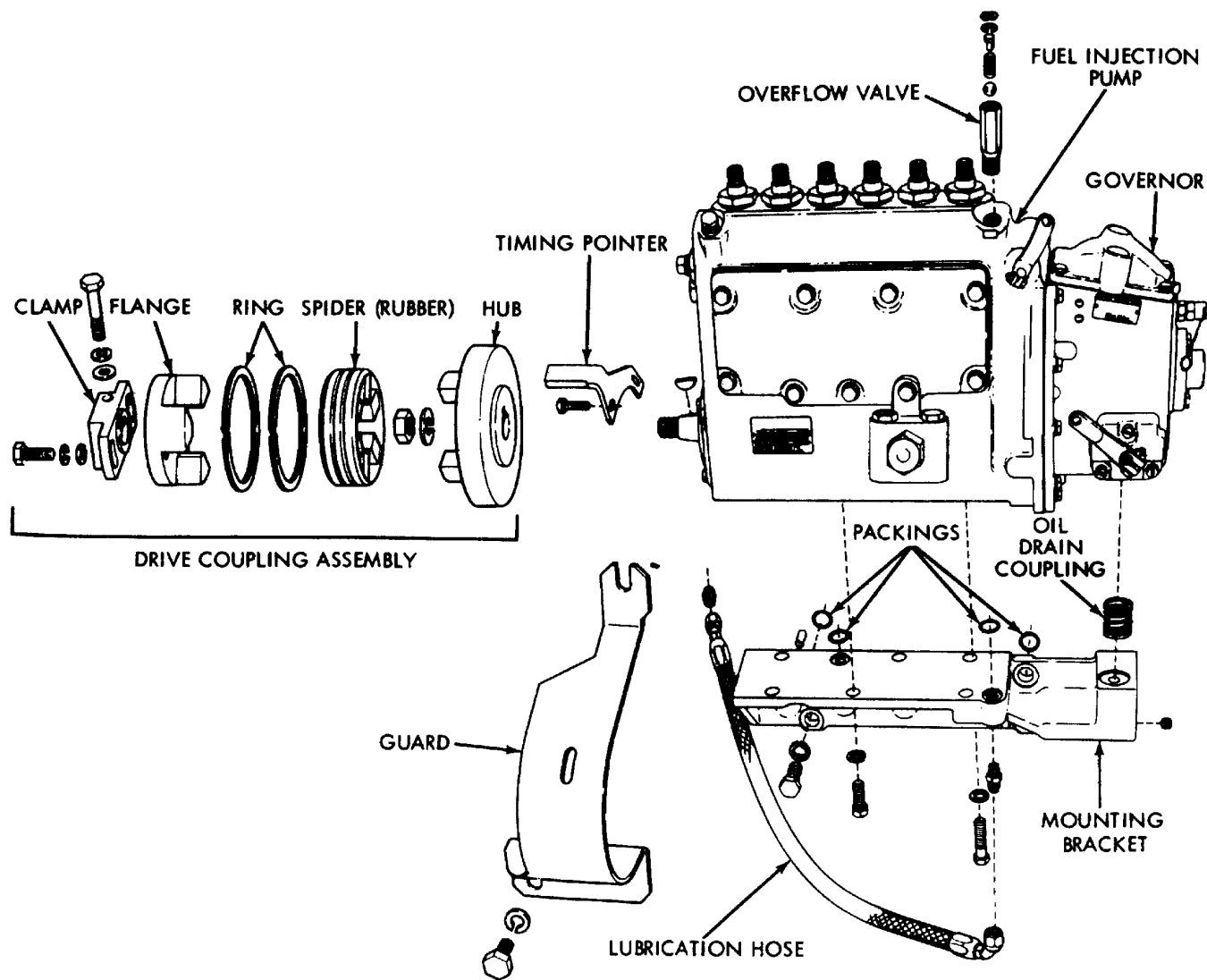
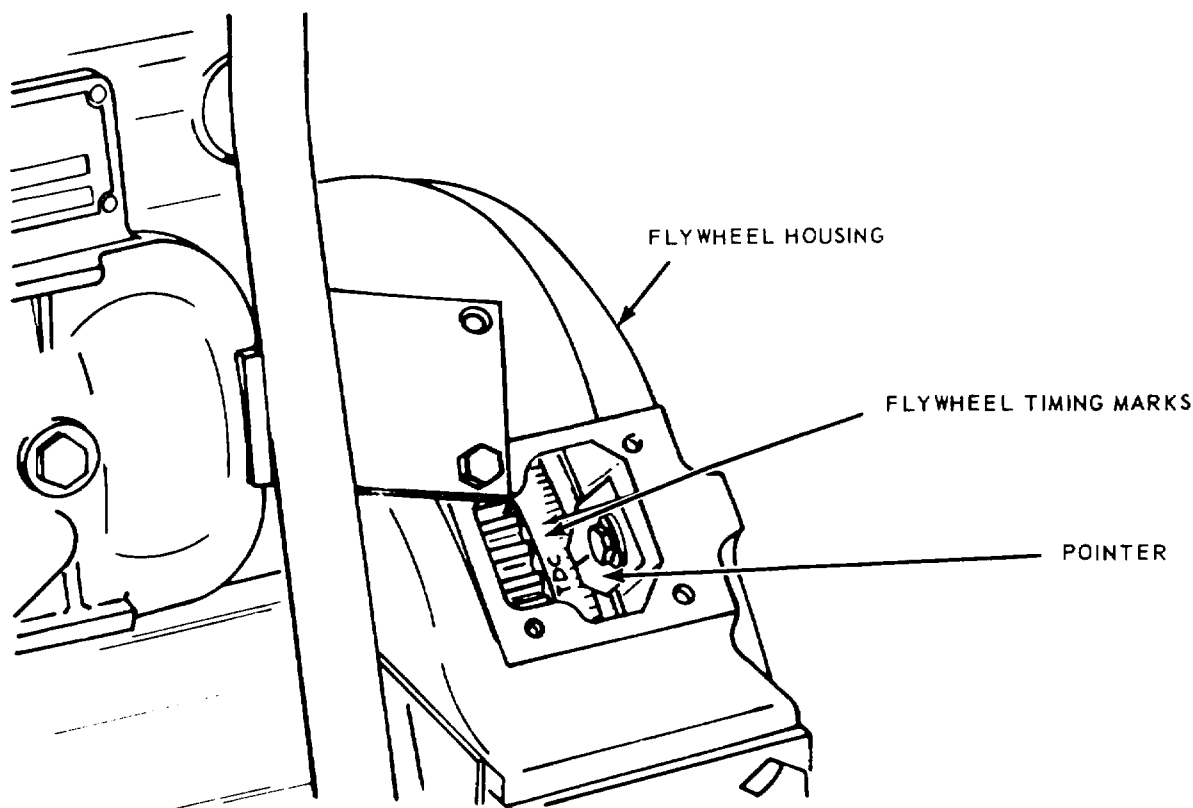

Figure 3-20. Injection pump and coupling.



6115-400-12/3-21

Figure 3-21. Engine timing pointer.

- (9) If the FPI mark on the coupling hub is on one side or the other of the pointer, it must be aligned, following the procedure listed below:
- (a) Loosen the two drive coupling flange attaching capscrews (fig. 3-23) just enough so that the drive coupling flange may be turned.
 - (b) Turn the coupling hub of the fuel injection pump to align the FPI mark with the pointer on the fuel injection pump. Tighten the two drive coupling flange capscrews securely.

Note. The timing marks must be accurately aligned and not "just about opposite each other."

- (10) The pump mounting bracket is positioned on the cylinder block by dowels, fixing the up-and-down position

of the center-line of the pump camshaft to the center-line of the driving shaft in the accessory side.

- (11) Tighten pump attaching capscrews and clamp to flange screws and recheck pump for alignment. (See figs. 3-20 and 3-22).
- (12) Connect the fuel inlet and outlet hoses and the fuel return and injection lines.
- (13) Install the injection pump flywheel guard and engine flywheel timing hole cover.
- (14) Vent the fuel system (para 3-31).

3-33. Fuel Injection Nozzle-Holder Assembly

a. *General.* Each fuel injection nozzle-holder (fig. 3-24) consists of two assemblies: the holder assembly and nozzle assembly. The

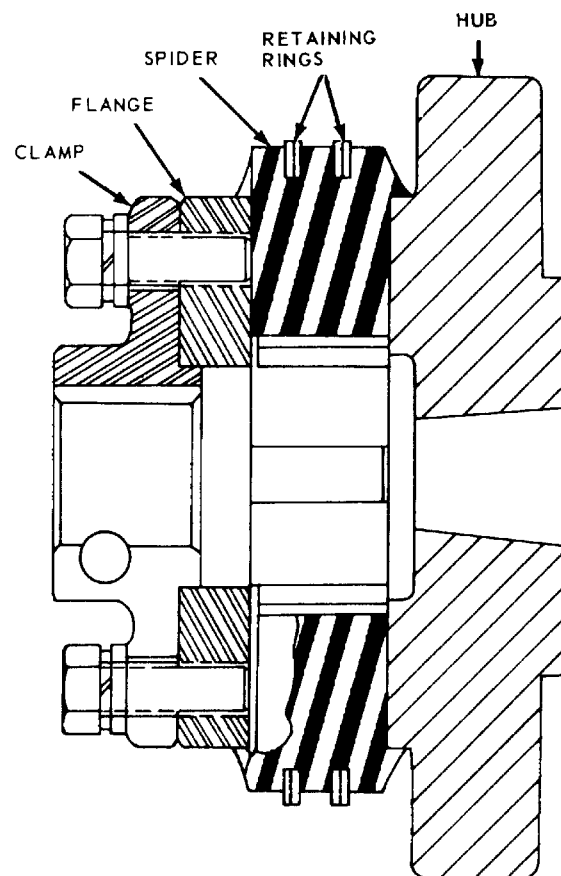
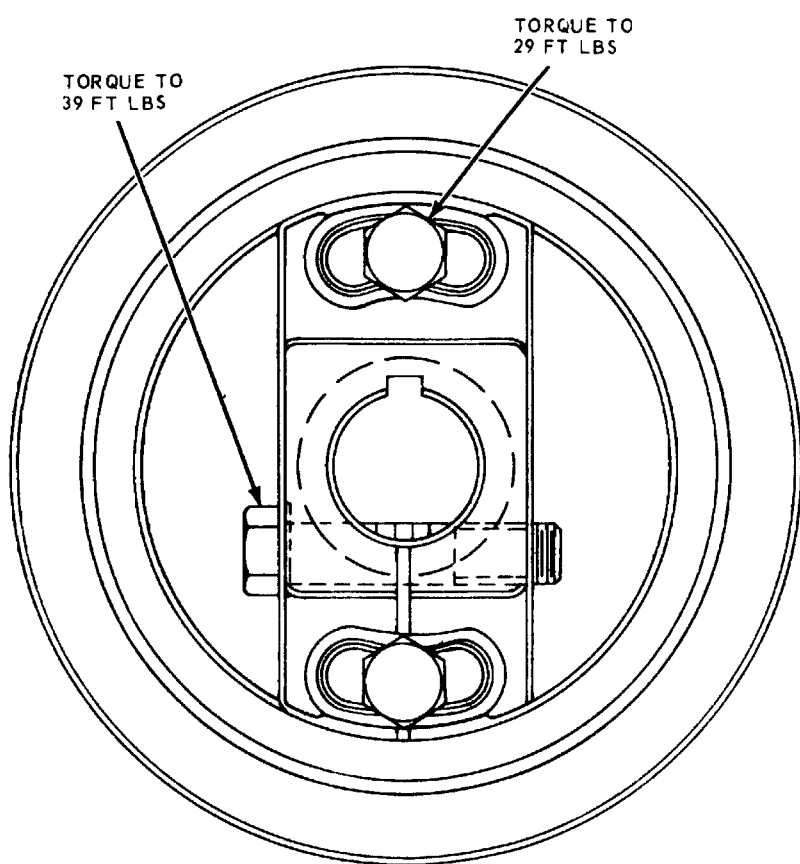

6115-400-12/3-22

Figure 3-22. Pump and coupling assembly.

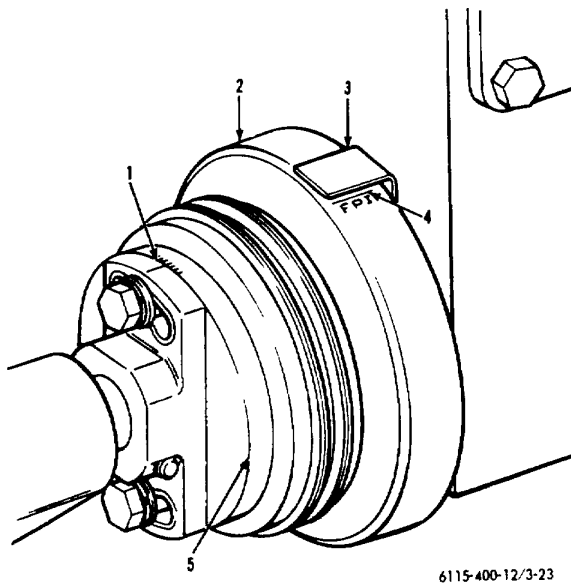

- 1 Degree marks (1 marks-3 degrees) Use when advancing or retarding pump timing to indicate degrees changed.
- 2 Coupling hub
- 3 Timing pointer
- 4 FPI timing mark
- 5 Coupling flange

Figure 3-23. Fuel pump coupling timing marks.

holder assembly is used to hold the nozzle in its correct position in the cylinder head and to provide a means of conducting fuel to the nozzle. The holder assembly consists of a holder body, spindle, spindle spring, pressure adjusting screw, adjusting screw locknut, protection cap, and a nozzle retaining nut. The nozzle consists of a nozzle valve and a nozzle valve body, in which are located four equally spaced spray orifices.

b. Removal and Installation.

- (1) Thoroughly clean valve rocker covers and surrounding area.
- (2) Remove valve rocker covers.
- (3) Disconnect and remove the fuel return manifold.
- (4) Using a fuel injection tube nut wrench (fig. 3-25), loosen the injection tube nuts from the top of the fuel injection nozzles.

- (5) Loosen the fuel injection tube nuts from the fuel injection line connectors.
- (6) Free the injection nozzle end of the tubes and remove the tubes from the engine.

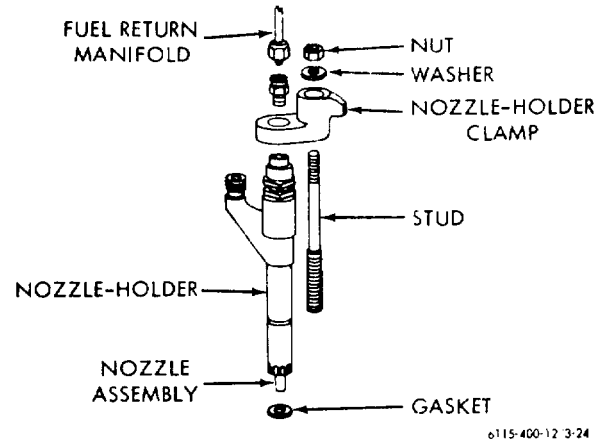

Figure 3-24. Nozzle-holder assembly.

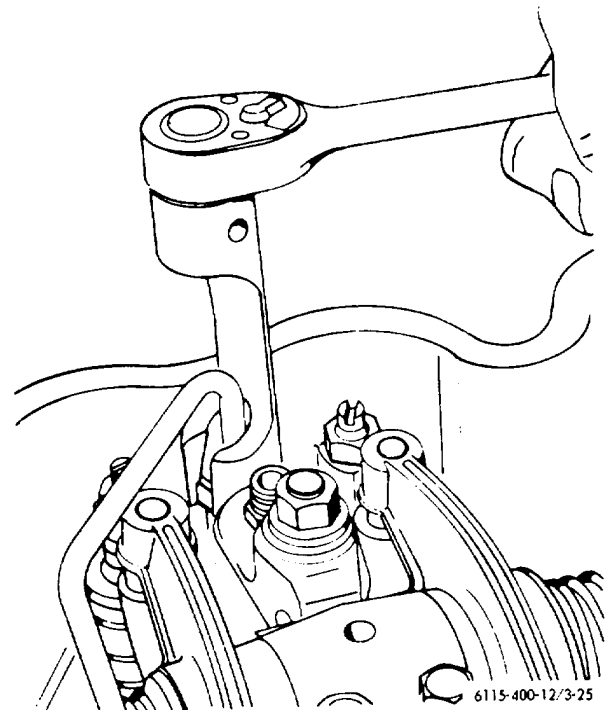

Figure 3-25. Fuel injection tubes, removal and installation.

Caution: Cover all fuel openings to prevent the entrance of dirt.

- (7) Remove the nut and washer securing the nozzle-holder clamps and remove the clamps.
- (8) Using a small pry bar, pry upward on the nozzle protection cap and pull the nozzles from the cylinder heads.

Caution: Use care when removing an injection nozzle to prevent striking nozzle tip.

- (9) Cover the openings in the cylinder heads to prevent the entrance of dirt.
- (10) Refer to figure 3-26 and remove carbon.

d. Installation.

- (1) Thoroughly clean the inside of the nozzle-holder sleeves before installing the nozzle-holder. When cleaning nozzle sleeve, make certain that the old nozzle-holder gasket is removed from the sleeve as a new gasket must be used when installing nozzle-holder. Make sure that no small particles of carbon are present in the nozzle sleeve which would prevent the nozzle-holder gasket from seating properly, thereby permitting "blow-by" from the cylinder.
- (2) Place a new nozzle-holder gasket, concave face down, in position on nozzle-holder and carefully insert nozzle-holder into position in the injection nozzle sleeve in the cylinder head.
- (3) Install the nozzle-holder clamp, and the washer and nut for each nozzle but do not tighten at this time. Install the fuel injection tubes, inserting one end of the tubes into the injection line connectors, then inserting the other end of the tubes into position in the injection nozzle-holders. Start the injection tube nuts but do not tighten at this time. Install the fuel return manifold.
- (4) Tighten the 3/4 inch nozzle-holder clamp nuts to a torque of 21 to 24 foot-pounds. Tighten the injection

tube and fuel return manifold nuts securely.

- (5) Start the engine and observe fuel injection tubes and fuel return manifold connections for fuel leakage. Correct any leaks found.
- (6) Make certain that the rocker cover gaskets are in good condition and install the valve rocker covers. Install the rocker cover sealing washers and the rocker cover capscrews.

3-34. Fuel Transfer Pump

a. The fuel transfer pump (fig. 3-27) is mounted directly on the fuel injection pump. The purpose of the transfer pump is to supply fuel, under low pressure, to the fuel gallery of the injection pump.

b. Periodically, the fuel transfer pump should be removed and inspected, as follows:

- (1) Disconnect the fuel lines from the fuel transfer pump. Remove the nuts and washers attaching the pump and remove pump.
- (2) Connect a piece of tubing to the fitting on the inlet side of the pump and place the free end of the tubing in 'a container of CLEAN diesel fuel.
- (3) Work the tappet assembly in and out, by hand until fuel flows from outlet side of the transfer pump. If a solid flow of fuel does not emerge from the outlet opening, weak valve springs and/or worn or damaged valves or valve seats are indicated.
- (4) Disassemble the transfer pump and inspect the components. If the valve seats are damaged in any way the transfer pump must be replaced as a unit.

3-35. Electrical Fuel Pumps

Refer to figure 3-28 and service the electric fuel pumps.

3-36. Fuel Tank

Refer to figure 3-29 for removal and installation of fuel tank.

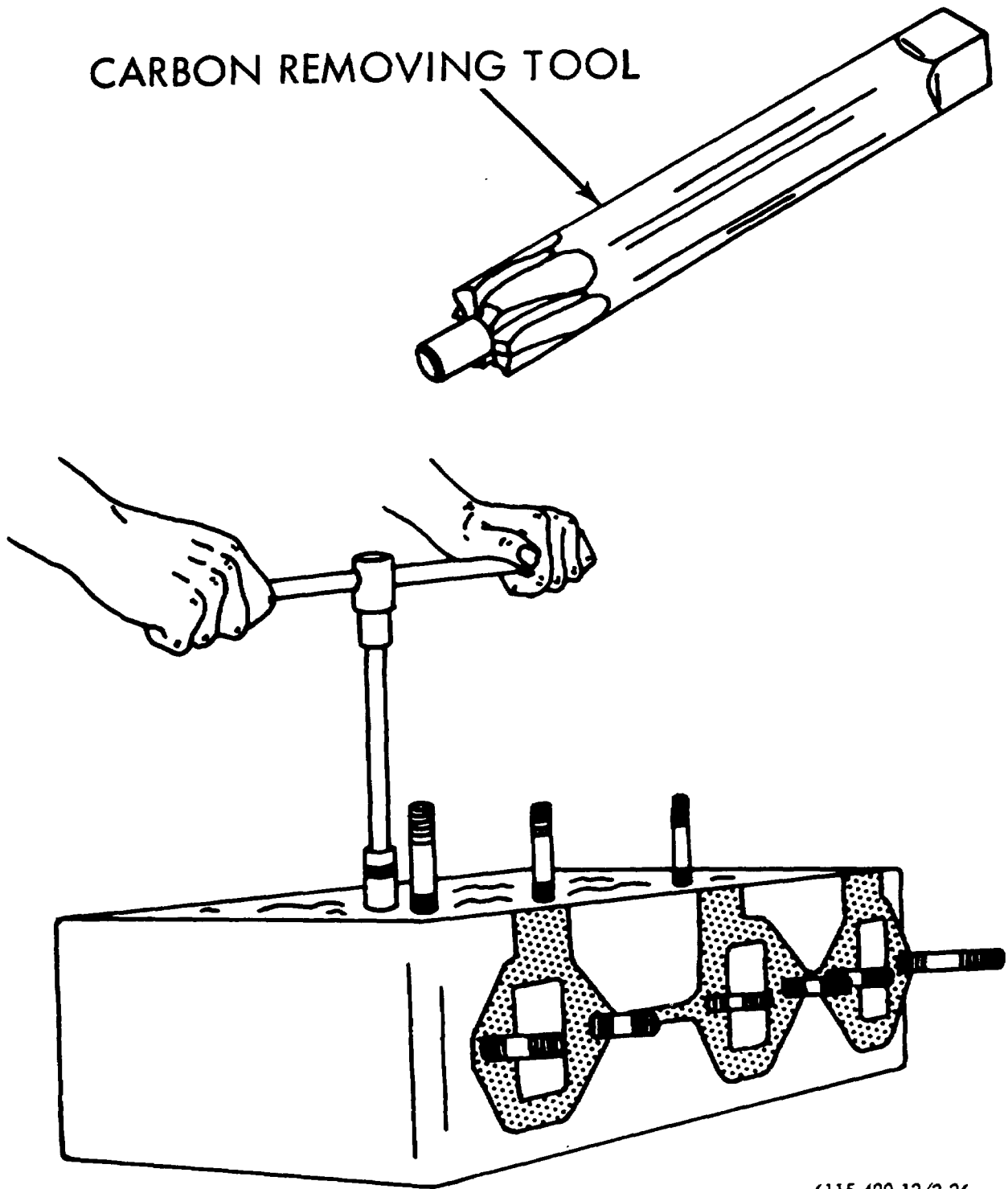

6115-400-12/3-26

Figure 3-26. Remove carbon.

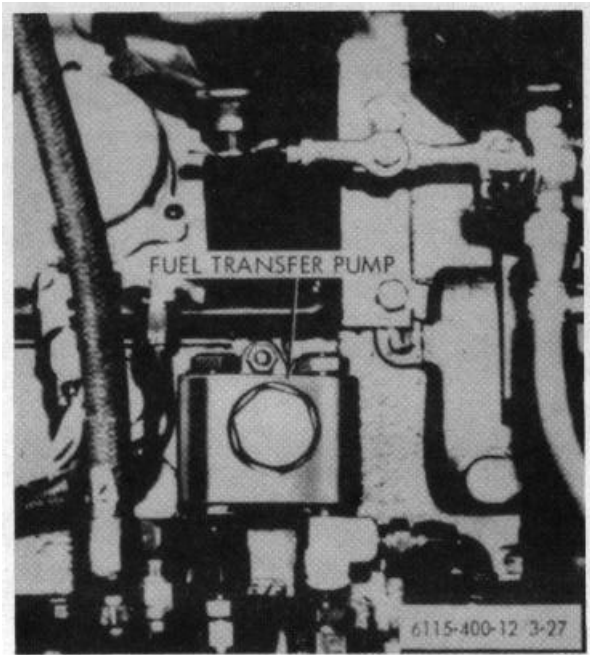

Figure 3-27. Fuel transfer pump, removal and installation.

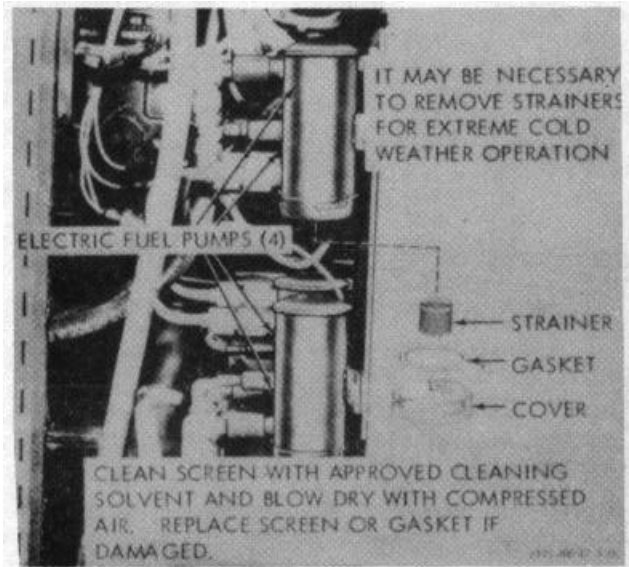

Figure 3-28. Electric fuel pump service.

3-37. Day Tank Float Assembly

Refer to figure 3-30 for removal of day tank float assembly.

3-38. Fuel Lines

- a. Refer to figure 3-31 for removal of fuel supply lines.
- b. Refer to figure 3-32 for removal of fuel injection lines.

3-39. Electrical Governor Hydraulic Actuator

Refer to figure 3-33 for removal of the hydraulic actuator.

3-40. Mechanical Governor - Fuel Injection Pump

a. The fuel injection pump governor assembly is lubricated through the engine lubricating system. No lubrication service on the injection pump and governor assembly is required.

b. Calibrating and test stands, and special tools are required to test, adjust, and repair the fuel injection pump and governor assembly. Removal, testing, adjusting and installation are to be accomplished at Field or Depot Level.

3-41. Checking Fuel System

"Missing" or uneven running of the engine, excessive vibration, and loss of power are indications of insufficient fuel supply to the engine. Before performing any of the following checks, make certain there is an ample supply of clean fuel in the fuel tank and the day tank and that the fuel selector valve is open.

a. Check for Admission of Air Into System.

Loosen vent screw in top of fuel filter (F2, fig. 3-17) retaining nut. Crank engine with starter. If fuel containing bubbles flows from around the vent screw, air being drawn into the system on the suction side of the fuel transfer pump is indicated. Correct this condition by tightening any loose low pressure fuel line connections between day tank and fuel transfer pump.

b. Check for Clogged Fuel Filters and Clogged or Collapsed Fuel Lines. Loosen the vent screw in top of F2 fuel filter shell retaining nut. Crank engine with starter. If a full flow of fuel is not obtained from around

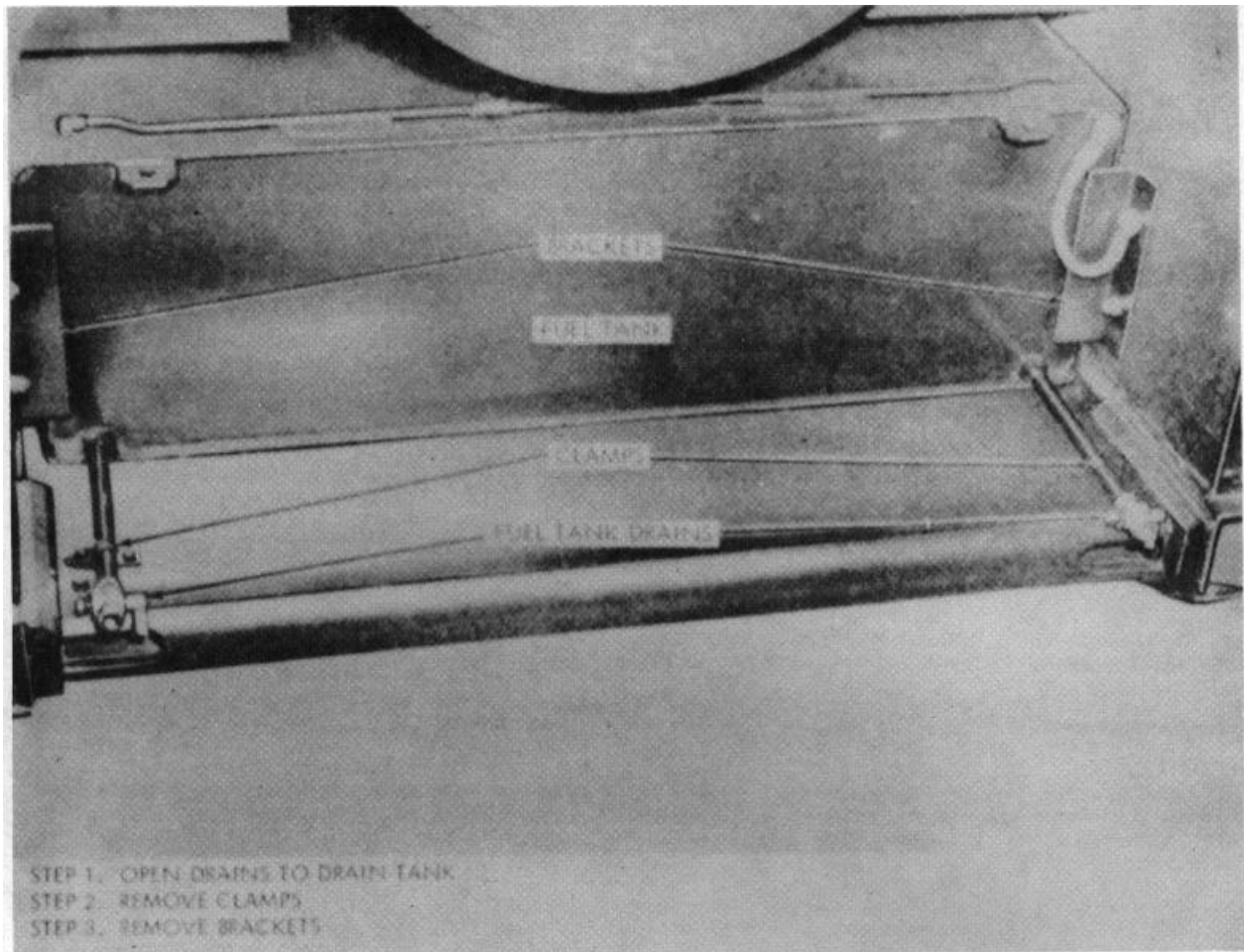

Figure 3-29 (1). Fuel tank, removal and installation.

the loosened vent screw, a clogged or collapsed fuel line is indicated. If this condition exists, replace the necessary fuel line.

c. Check for Inoperative Fuel Transfer Pump or Fuel Pressure Relief Valve.

- (1) The fuel transfer pump should deliver more fuel to the fuel gallery of the fuel injection pump than is required for engine operation. The fuel pressure relief valve, connected into the fuel return passage of

the fuel injection pump, controls maximum fuel pressure within the fuel battery of the injection pump. The relief valve is set to open between 8 and 30 psi. When fuel pressure within the fuel gallery of the injection pump exceeds relief valve setting, the pressure relief valve opens and allows excess fuel to return to the fuel tank through the fuel filter head and fuel return line.

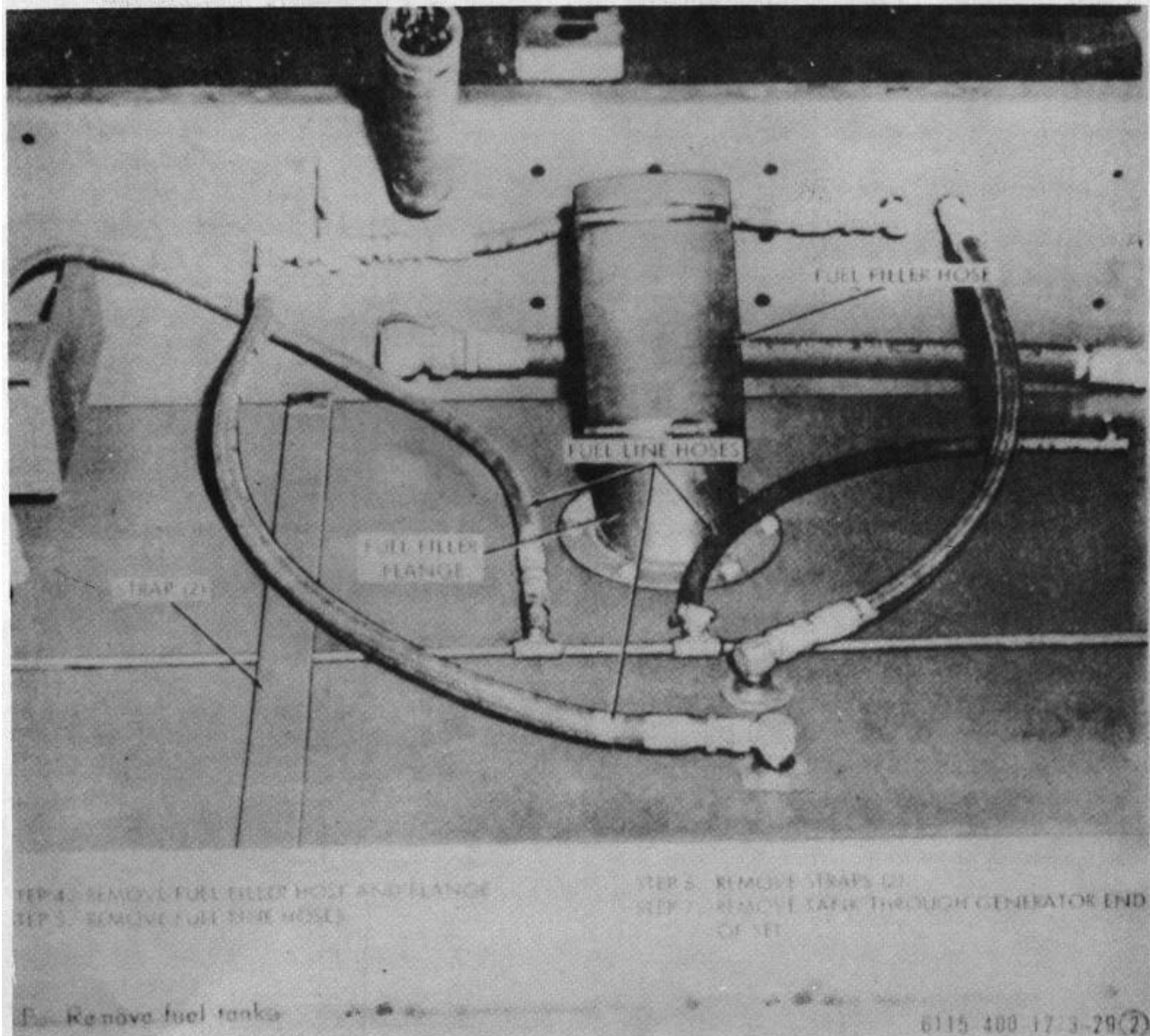

Figure 3-29 (2). Continued.

- (2) Check for an inoperative fuel pressure relief valve or fuel transfer pump as follows:
 - (a) Install a fuel pressure gage between the outlet of the F2 fuel filter and the inlet of the fuel injection pump.
 - (b) Start engine and operate at 60 cycles. Observe the fuel pressure gage. Gage should indicate a pressure of 8 to 30 psi. If gage indicates a pressure below specified minimum, stop engine and disconnect the relief valve-to-fuel tank return line from the relief valve.
 - (c) Start engine and operate at 60 cycles. If gage indicates a pressure below the specified minimum and a full flow of fuel is observed from disconnected return line, the indication is that the pressure relief valve is stuck in the open position and the valve must be replaced as a unit. However, if gage

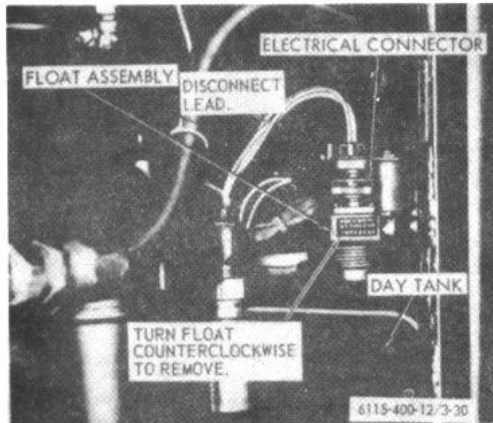

Figure 3-30. Day tank float, removal and installation.

indicates a pressure below specified minimum and little or no fuel is observed from disconnected return line, an inoperative fuel transfer pump is indicated. The pump must be removed, inspected, repaired, or replaced as a unit.

- (d) If a pressure above 30 psi is indicated by the gage, the fuel pressure relief valve is defective and must be replaced as a unit.
- (e) Stop engine and connect fuel return line to fuel relief valve.

d. *Check for Inoperative Fuel Injection Nozzles.* Run engine at 60 cycles and "cut out" each fuel injection nozzle in turn by loosening the fuel injection line nut attaching the line to the fuel injection pump.

Caution:

Keep hands away from loosened nuts while performing this test.

A decrease in engine speed with injection line nut loosened indicates that the fuel injection nozzle for that cylinder is functioning properly. If engine speed does not decrease, the nozzle is defective and must be removed, tested, adjusted, and cleaned.

e. *Check for Inoperative Fuel Injection Pump.*

- (1) Do not replace the fuel injection pump before having a compression test made.
- (2) The compression test will indicate whether or not burned or stuck valves, worn or scored pistons and sleeves, worn or stuck rings, etc., are causing the improper engine operation. (Refer to direct and general support maintenance.)
- (3) If all causes for insufficient fuel supply have been eliminated, and the engine still runs unevenly and normal engine performance is not obtained, the fuel injection pump will be considered at fault and should be repaired or replaced.

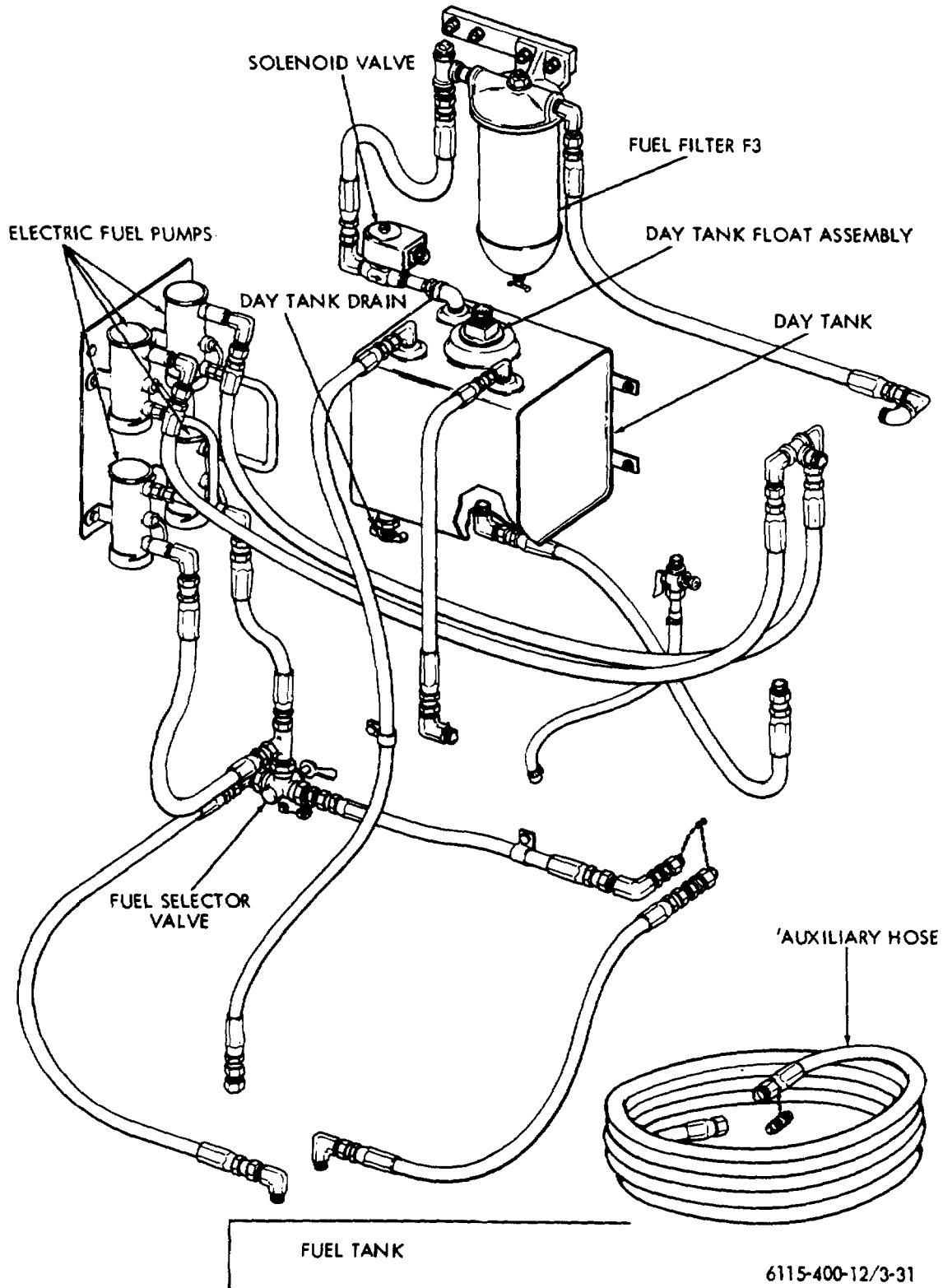
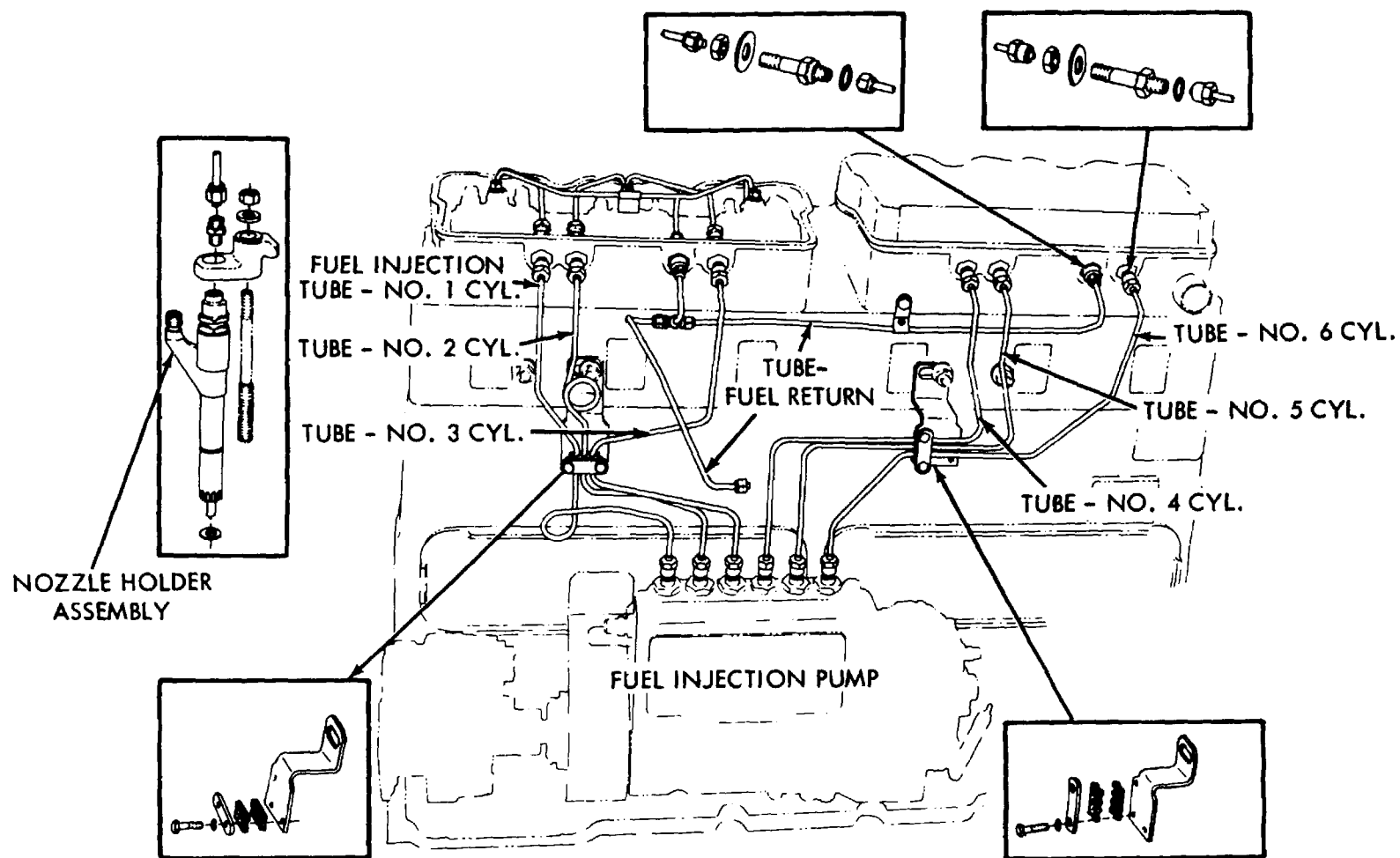

Figure 3-31. Fuel supply lines, removal and installation.



6115-400-12/3-32

Figure 3-32. Fuel injection lines, removal and installation.

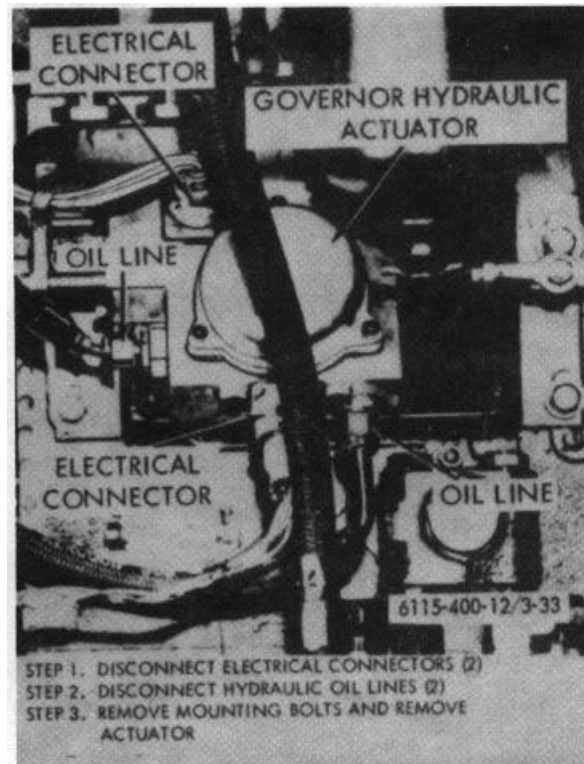

Figure 3-33. Electric governor hydraulic actuator, removal and installation.

Section X. ENGINE COOLING SYSTEM

3-42. General

The cooling system consists of a radiator, water pump, fan, thermostats, shutter and shutter controls, and the necessary lines, fittings, and linkage to connect these components. The flow control thermostat regulates the flow of coolant pumped through the engine block by the water pump to cool the engine. The shutter is controlled by the shutter control thermostat and can also be operated manually.

3-43. Radiator Grill

Refer to figure 334 and remove the radiator grill.

3-44. Radiator Shutter and Control

a. Description.

- (1) *Shutter.* The vanes are made of extruded aluminum alloy and are mounted in 5/16 inch nylon bearings. Shutters must be checked and cleaned at regular

inspections Shutters should be opened and closed manually to note that vanes operate absolutely free. Vane bearing should be washed with cleaning fluid and blown out with air. Do not lubricate nylon vane bearings.

- (2) *Automatic Control.* The thermostatic element is mounted in the bottom tank of radiator and operates shutter by thermal expansion. The control is so arranged that shutter will completely open in approximately 8 to 10 degree range. The thermostat opens shutter and is closed by return spring. Control should be adjusted so that shutter is closed when engine is cold.

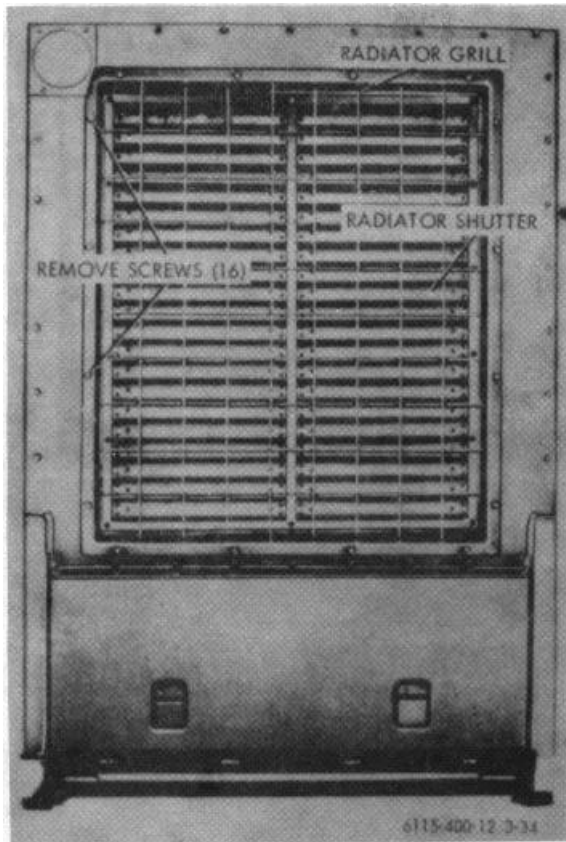

Figure 3-34. Radiator grill, removal and installation.

b. Shutter Removal. Refer to figure 3-5 and remove the Shutter.

c. Shutter Control Adjustments.

- (1) If shutters are not opening at desired temperature range, remove control assembly and check for proper dimensional setting of power element in control assembly of 2 15/16 inches. See figure 3-36.
- (2) To remove slack from linkage: (Temperature must be under 150 degrees.)
 - (a) Turn adjusting screw (A, fig. 3-36) clockwise until plunger "B" bottoms. Shutter should be closed.

- (b) Back off adjusting screw one to two turns to allow for expansion and pre-travel.
- (c) During extreme cold weather, adjusting screw may be backed off five or six turns to maintain higher engine temperature.
- (d) Control should be readjusted for warm weather.
- (e) Should adjusting screw turn too freely, tighten jam nut "C".

Full open position of shutters is at an angle of approximately 70°, (not 90°). Maximum air flow is attained between 60° and 70° of open.

3-45. Radiator

Remove radiator as follows:

- a. Remove radiator grill and front panel.
- b. Refer to figure 8-47 and remove radiator.

Refer to figure 8-38 for removal of water inlet manifold and connections.

3-45. Water Outlet Manifold

Refer to figure 3-39 for removal of water outlet manifolds and connections.

3-47. Thermostats

a. Removal and Installation. Refer to figure 8-39 and remove the flow control thermostats.

b. Thermostat Testing. Test the thermostats for proper opening by submerging in a container of water. Position a thermometer in the water and heat the container. When the thermometer indicates 180°, the thermostat should start to open and should be completely open at 195°F. If the thermostat does not meet the above requirements, replace the thermostat.

3-48. Water Pump

a. General. A centrifugal-type water pump assembly (fig. 3-40 (1)) is provided for circulating coolant through the engine and radiator. The water pump is mounted in the lower right-rear corner of the timing gear housing and is pulley-driven by a belt driven by the crankshaft pulley. The pump shaft is supported in the pump bearing sleeve by a ball bearing on pulley end and a roller bearing on rear end of the bearing sleeve.

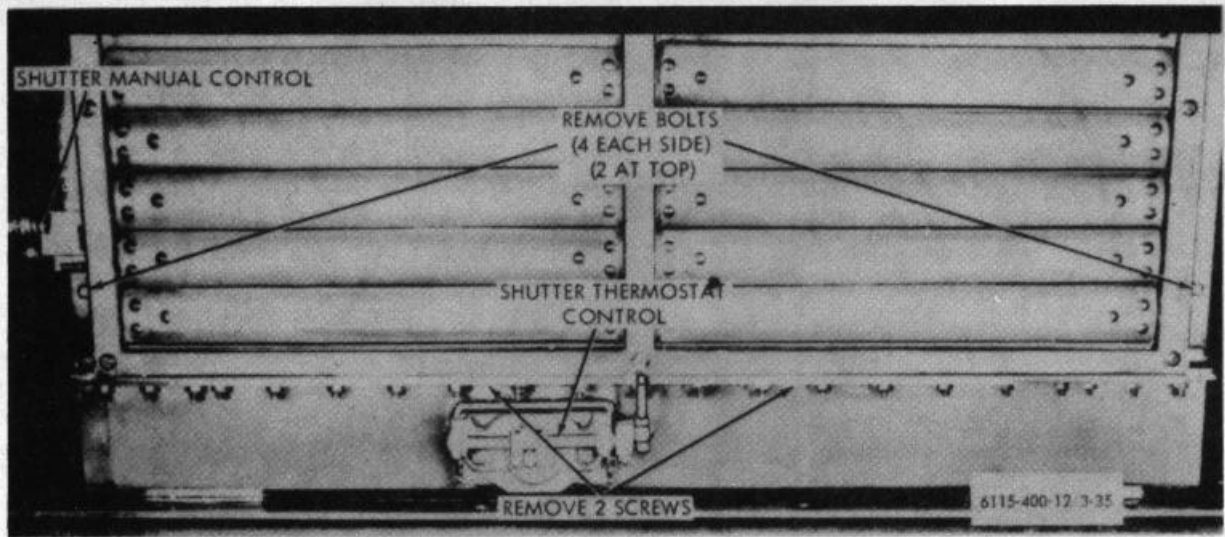

Figure 3-35. Shutter, removal and installation.

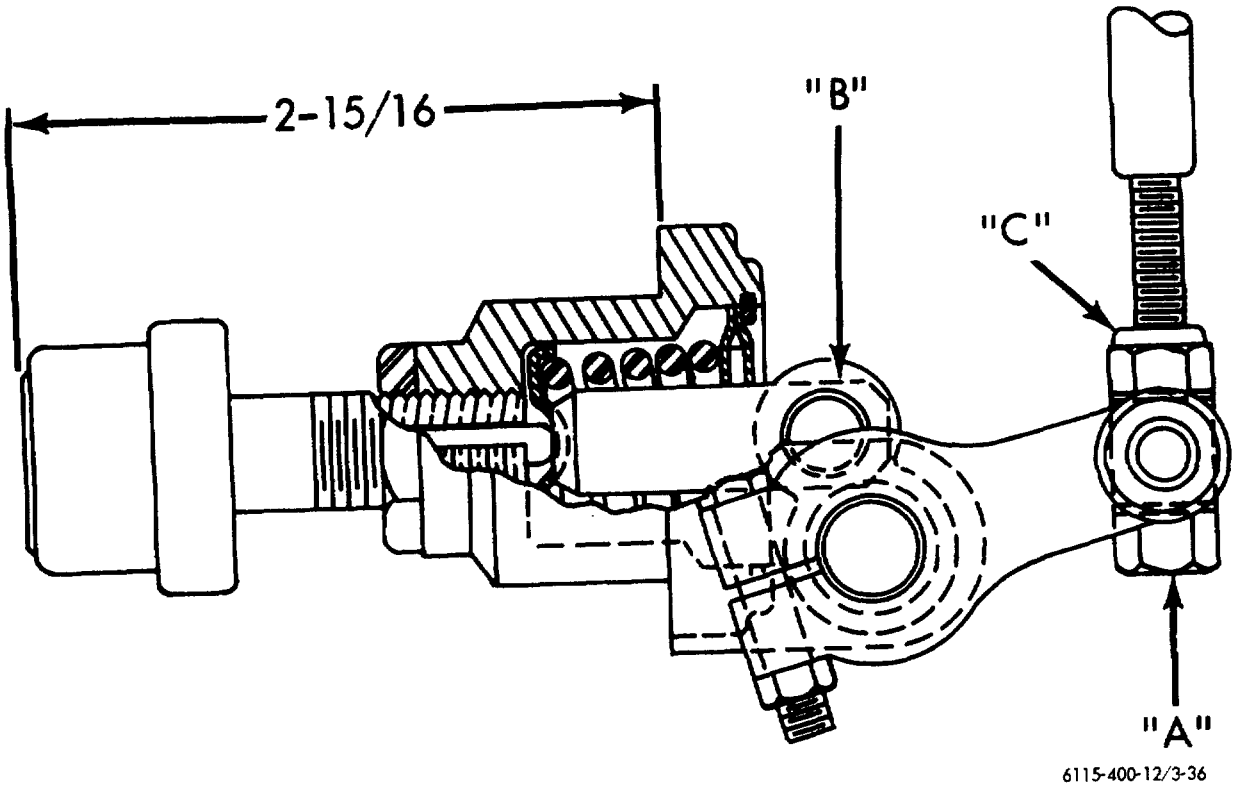

Figure 3-36. Shutter control adjustments.

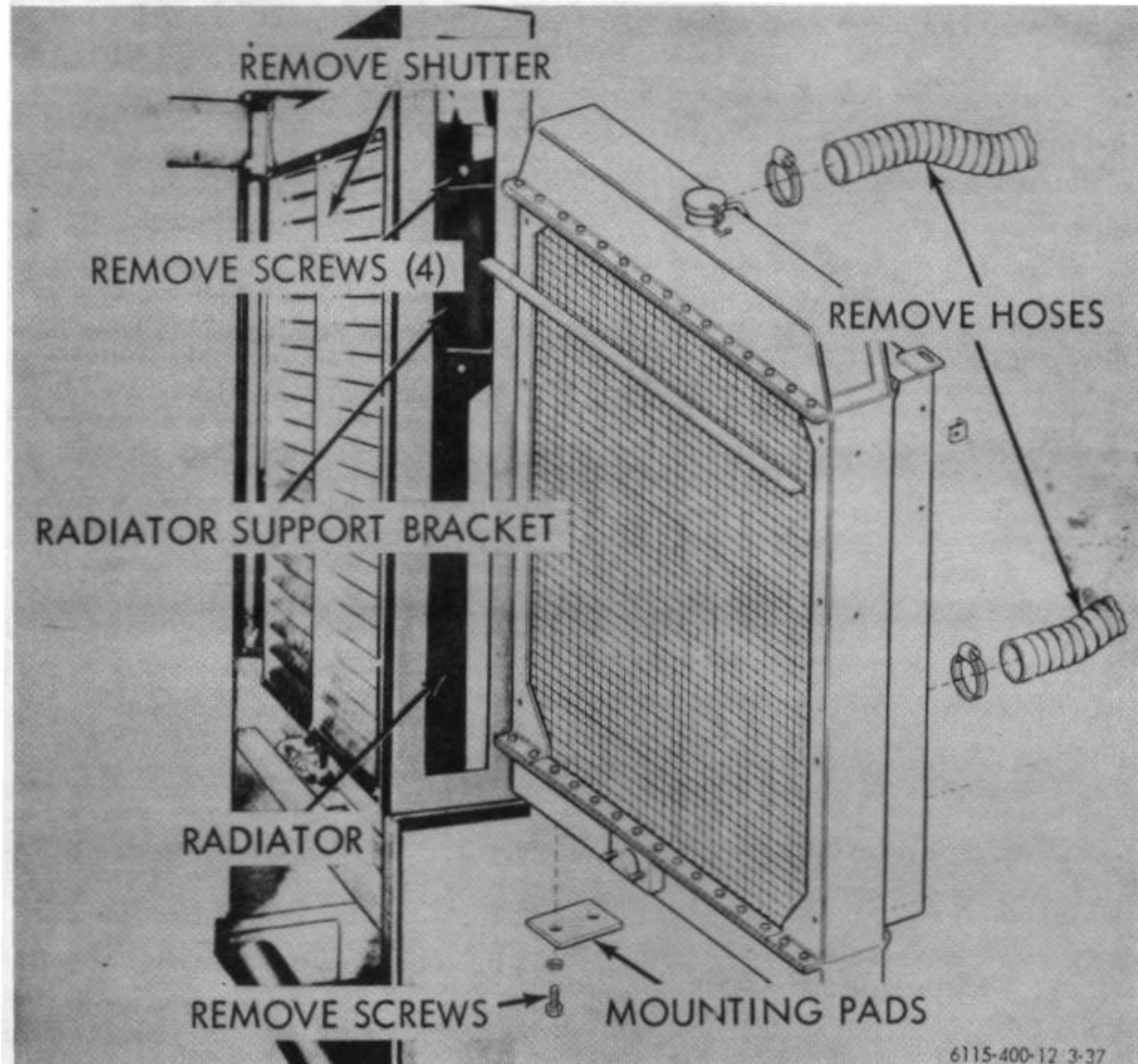

Figure 3-37. Radiator, removal and installation.

b. Removal and Installation.

- (1) Drain the cooling system. Disconnect radiator lower hose from pump inlet cover.
- (2) Remove idler bracket adjusting capscrew and remove water pump drive belt.
- (3) Remove water pump pulley and remove idler bracket.
- (4) Remove the capscrews securing filler pipe support and remove support and gasket from bearing sleeve.
- (5) Remove clamps securing hoses to bypass tube.
- (6) Remove bypass tube.
- (7) Remove capscrews and lockwashers securing bypass elbow to pump cover; force oil cooler tube and bypass elbow down and remove them as an assembly. Remove the gasket.
- (8) Remove intercooler hose from top of water pump body.
- (9) Loosen clamps securing water pump body to water inlet manifold bonnet

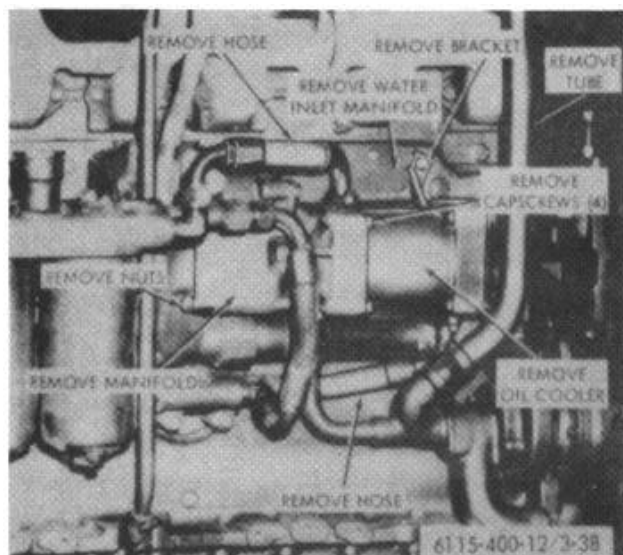

Figure 3-38. Water inlet manifold, removal and installation.

tube hose; force hose onto bonnet tube.

Note.

If hose is too hard or inflexible to be worked onto tube, cut hose and remove it completely; replace with a new hose.

- (10) Remove capscrew and lockwasher securing oil cooler support bracket to the water inlet manifold.
- (11) Remove capscrew and lockwashers securing water manifold assembly to water inlet manifold. With hoses intact, lift oil cooler end up as high as possible and wire oil cooler to the engine in this position to allow clearance for the water pump removal.
- (12) Remove nuts and lockwashers from pump mounting studs, slide pump body towards rear of engine and off

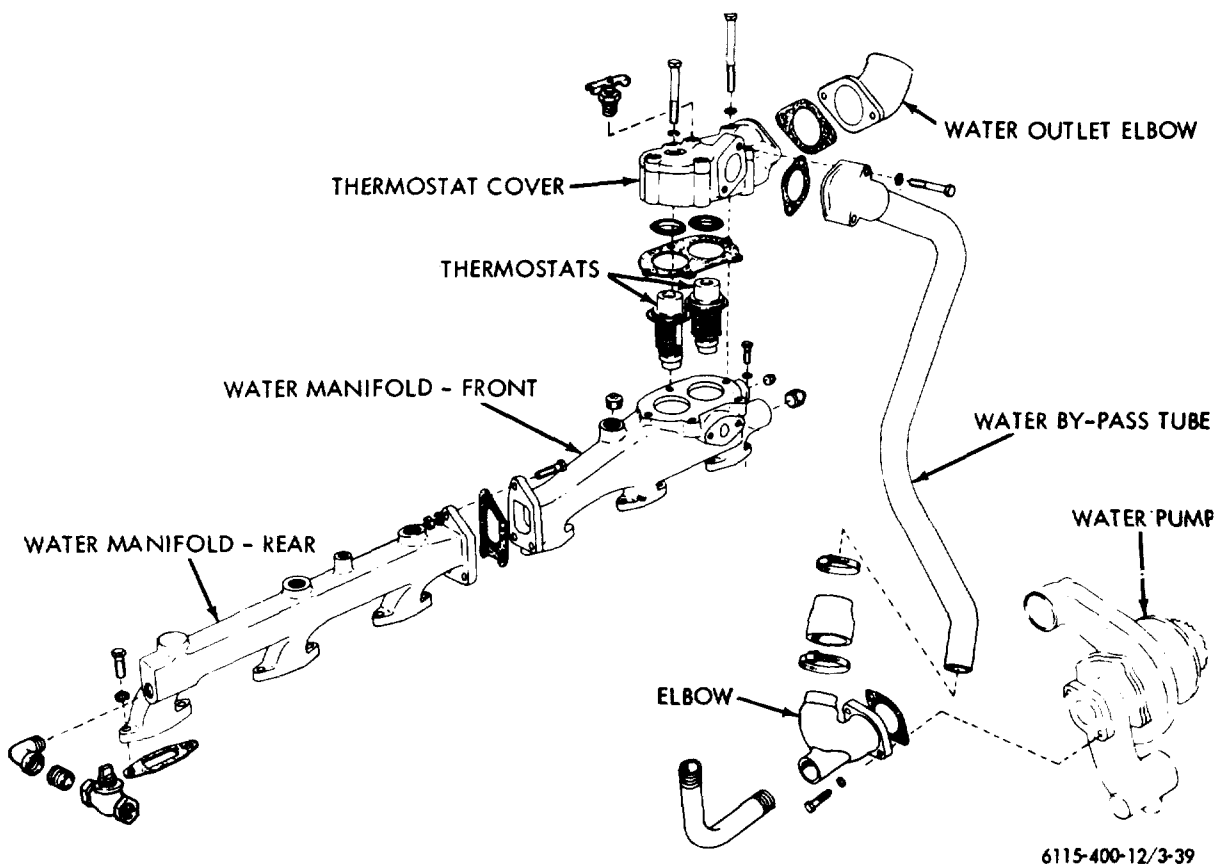
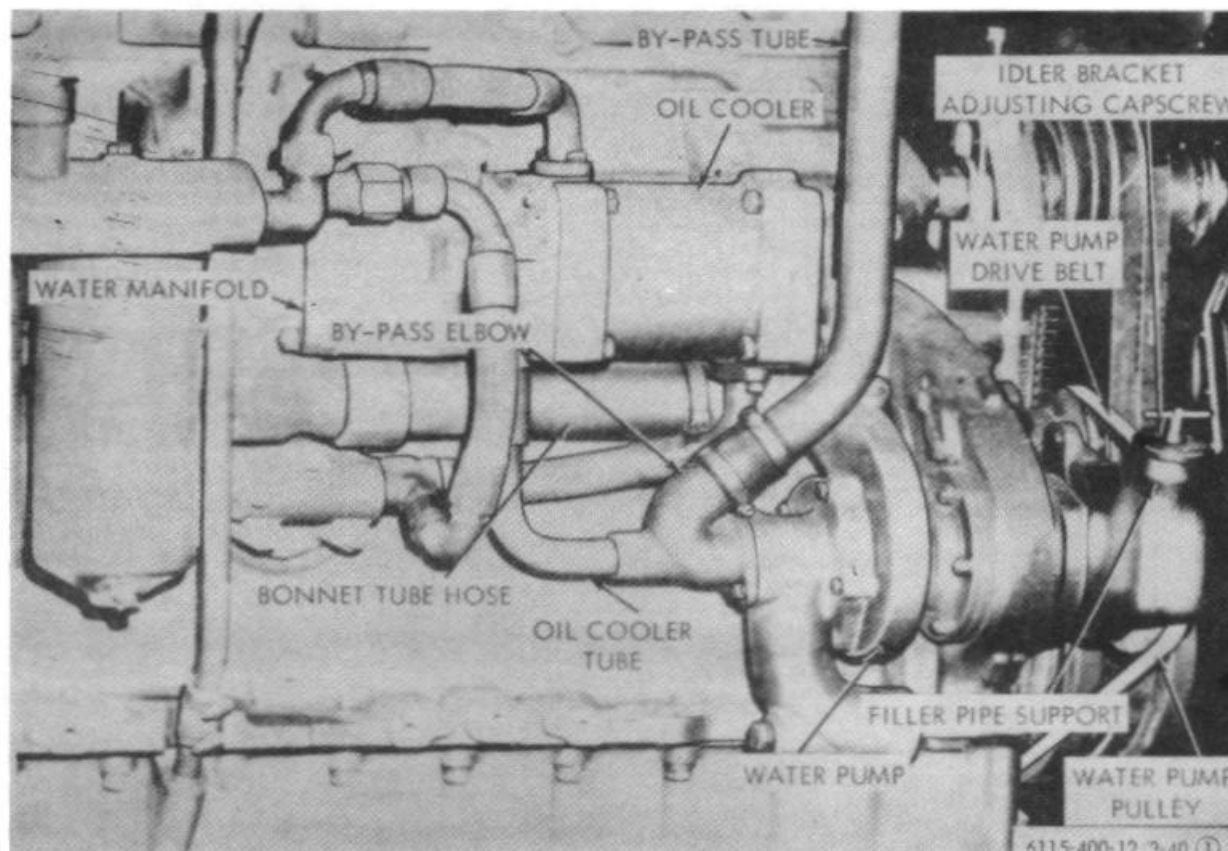

Figure 3-39. Water outlet manifold and thermostat, removal and installation.



Water pump detail.

Figure 3-40 (1). Water pump service.

studs, turn pump body downward, and remove water pump and mounting gasket.

Note.

Install water pump by reversal of removal procedure. Use new gaskets and packings. Adjust water pump drive belt to the proper tension. Fill cooling system. Check all connections for coolant leaks.

3-49. Fan and Belt Guards

Refer to figure 3-41 and remove belt guards and fan guards.

3-50. Fan Belts

a. General. It is important that fan and water pump drive belts be inspected frequently to make certain no oil or grease has accumulated, and that proper belt tension is maintained. Replace badly worn,

burned, oil/grease soaked belts. The fan driving belts furnished are a matched pair of identical length. If only one belt replacement is required, both belts **MUST** be replaced.

b. Removal.

- (1) Loosen the spindle clamping retaining nut at rear of fan hub mounting bracket and loosen locknut securing adjusting capscrew that protrudes through the fan hub spindle (fig. 3-42).
- (2) Turn capscrew until enough slack is obtained to facilitate removal of the fan belts, then remove belts.

c. Installation.

- (1) Position belts on fan hub and crankshaft pulley.

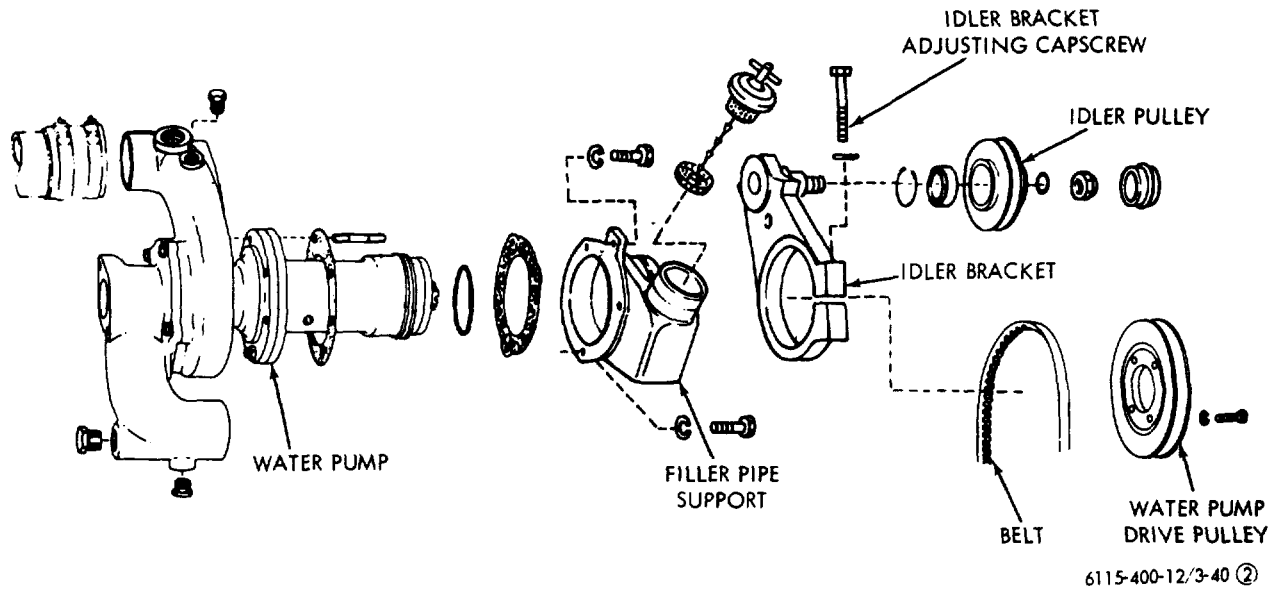

Removal.
Figure 3-40 (2). Continued.

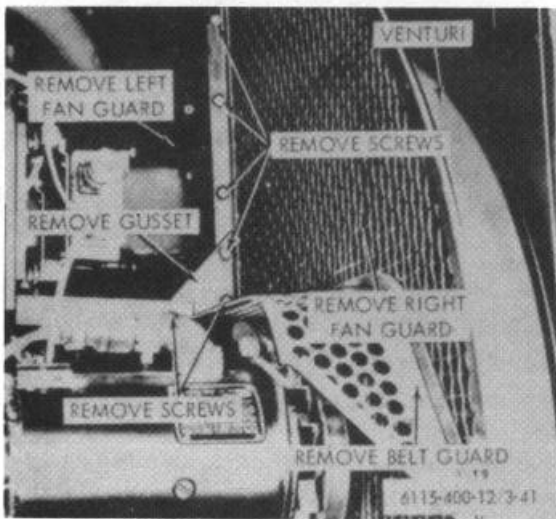

Figure 3-41. Fan and belt guards, removal and installation.

- (2) Turn adjusting capscrew until belts can be pressed inward 3/4 inch to 1 inch at a point half-way between fan hub and crankshaft pulley.
- (3) Tighten locknut and spindle retaining nut.

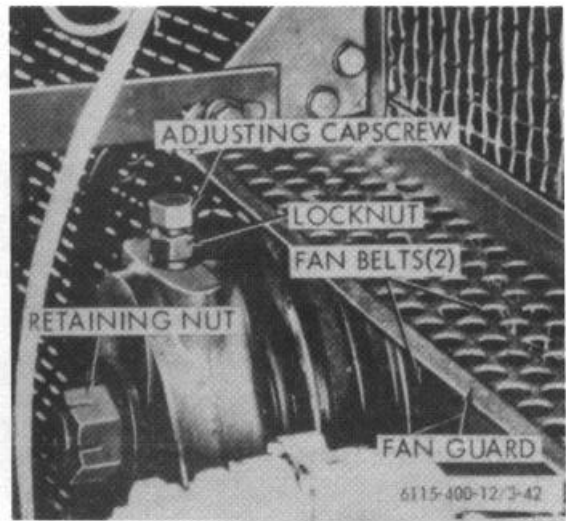

Figure 3-42. Fan belt, removal and installation.
3-51. Fan and Fan Hub

Removal and Installation. Remove the fan guard (para 3-49) and fan (fig. 3-43).

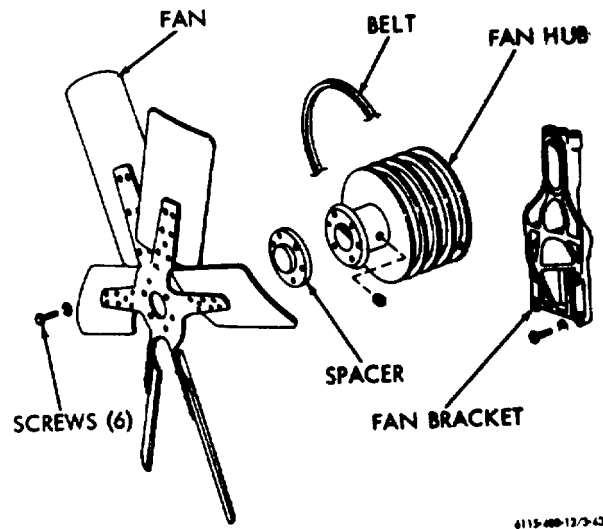

Figure 3-43. Fan and fan hub, removal and installation.

Section XI. TURBOCHARGER AND MANIFOLDS

3-52. Turbocharger

Note.

While the turbocharger is off the engine, keep all intake and exhaust manifold openings covered. This will prevent foreign objects from accidentally getting into the manifolds and damaging the turbocharger/engine when the engine is put into operation.

a. Removal.

- (1) Allow the turbocharger (fig. 3-44) to cool if the engine has been run. Remove the engine hood.
- (2) Remove the air cleaner to turbocharger hose.
- (3) Remove exhaust outlet and diffuser.
- (4) Remove oil inlet hose.
- (5) Disconnect and remove the oil drain line.
- (6) Disconnect the turbocharger to intake manifold pipe.
- (7) Remove stud nuts and washers attaching turbocharger to exhaust manifold.
- (8) Remove the turbocharger assembly.

b. Procedure Before Installing Turbocharger.

- (1) Service the air cleaner.
- (2) Replace engine lubricating oil filter elements. Renew lubricating oil in the oil pan.
- (3) Check exhaust manifold for cracks, foreign material, condition of manifold gaskets, tightness of manifold capscrews, and flatness of the exhaust manifold turbocharger mounting pad.
- (4) Check intake manifold and air inlet elbow and hose for cracks, foreign material, condition of manifold mounting gaskets, and torque of the manifold capscrews.
- (5) Completely remove oil inlet and oil drain lines. Examine for sludge or clogging and clean if necessary. Any oil inlet or drain line found crimped or dented enough to restrict oil flow must be replaced.
- (6) Replace all deteriorated oil hose connections.
- (7) Make certain all air and oil hose clamps are tight.

- (8) Make certain the gaskets do not extend into port openings of the intake manifold, exhaust manifold, air inlet elbow, turbocharger mounting adapter, and mounting pads.
- (9) Just prior to mounting the unit, prime the lubrication system. Fill the center housing oil reservoir with new, clean oil through the oil inlet. Turn rotating assembly by hand to coat the bearings and thrust collar with oil.

c. *Turbocharger.*

- (1) Install new gasket and mount the turbocharger on the exhaust manifold. Lubricate mounting studs with an antiseize compound. Install washers and stud nuts.
- (2) Install the air cleaner to turbocharger hose.
- (3) Connect lower end of oil inlet hose to the lubricating oil adapter located on side of the engine block.

Caution:

Do not connect the oil inlet line to the turbocharger until step 5 is performed.

- (4) Remove electrical connector from fuel solenoid at fuel injection pump.
- (5) Crank engine until a free flow of oil is observed, coming from upper end of the oil inlet hose, then connect it to the turbocharger oil inlet.
- (6) Continue to crank engine until oil flows from turbocharger oil outlet.
- (7) Connect lower end of drain line to the turbocharger drain nipple on side of oil pan.
- (8) Using a new gasket, assemble upper end of oil drain line to the turbocharger.
- (9) Assemble diffuser or diffuser ring to the turbocharger and exhaust manifold.
- (10) Install exhaust elbow, exhaust pipe, and engine hood.
- (11) Reconnect electrical connector to fuel solenoid.
- (12) Upon completion of the installation, run engine and check turbocharger operation.

Caution:

Never operate engine while the air inlet hose between air cleaner and turbocharger or the exhaust outlet piping is disconnected. Clothing or foreign objects can be drawn into the compressor inlet. Discharged carbon particles and hot exhaust gas from the turbine outlet can cause personal injury.

3-53. Intake Manifold

a. *General.*

- (1) The air intake system includes the air cleaner, the compressor side of the turbocharger, and the intake manifold with intercooler.
- (2) It is important to provide an ample supply of fresh air to the combustion chambers. Insufficient air will limit the amount of fuel the engine can burn and will lead to loss of power, excessive exhaust smoke, and high fuel consumption. Contaminated air leads to worn engine parts, high oil consumption, and eventual: engine failure.
- (3) The intake manifold is sealed to the cylinder head with steel-asbestos gaskets and secured in place with capscrews and washers.

b. *Intake Manifold Removal.*

Note.

Remove head.

Refer to figure 345 and remove manifold as follows:

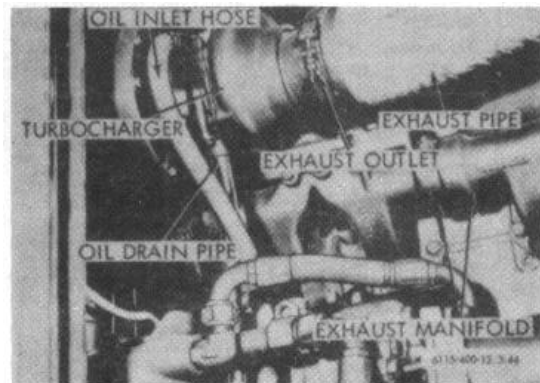

Figure 3-44. Turbocharger, removal and installation.

- (1) Remove capscrews securing the fuel filter assembly to the intake manifold. With the fuel filter assembly and hoses intact, carefully let it hang to one side.
 - (2) Remove ether primer.
 - (3) Remove air inlet pipe.
 - (4) Remove clamping plates securing fuel injection tubes to front and rear supporting brackets.
 - (5) Remove breather tube.
 - (6) Open drain cocks on both end bonnets and allow water to drain.
 - (7) Disconnect water inlet and outlet hoses from front end bonnet by removing attaching capscrews and lockwashers.
 - (8) Remove collector manifold tube assembly.
 - (9) Remove intake manifold.
- c. *Disassembly of Manifold and Intercooler.*
- (1) Remove front and rear end bonnets and gaskets. Remove packing from rear end bonnet.
 - (2) To loosen intercooler from intake manifold (fig. 3-46), carefully

wedge the header away from the front of the manifold to break the gasket sealing compound. Slide intercooler core out of the intake manifold. Do not drive on rear end of intercooler core.

Note.

Pressure test intercooler core assembly with 70 to 75 psi air pressure. Immerse intercooler core in hot water for a sufficient length of time until the tube bundle temperature is up to approximately 180°F. Use an improvised seal, such as a drilled metal plate and a thick rubber gasket. Drill and tap a hole in the plate and attach an air pressure hose to it; secure the plate to the front of the intercooler core with capscrews and nuts. Secure a metal plate and a rubber gasket to the rear of the intercooler core with C clamps.

- (3) Observe for air bubbles around the tubes. If any leaks are found, the intercooler core must be replaced.
 - (4) Check collector manifold tube for damage or clogged condition. Clean or replace as necessary.
- e. *Intake Manifold with Intercooler installation.*
- (1) Install two temporary guide studs in the front end of the intake manifold.
 - (2) Cement a new gasket (split type) to the front end of the intake manifold using a gasket sealant on both sides of the gasket.
 - (3) Make certain the open end of the baffles on the intercooler core are to the top and slide the intercooler core into the intake manifold.
 - (4) Install gasket and front end bonnet; secure with capscrews and lockwashers.
 - (5) Remove temporary guide studs and install capscrews and lockwashers.
 - (6) Install a new packing in the rear end bonnet.
 - (7) Cement a new gasket (split type) to the rear end of the intake manifold using a gasket sealant on both sides of the gasket.
 - (8) Install rear end bonnet to intake manifold; secure with capscrews and lockwashers.

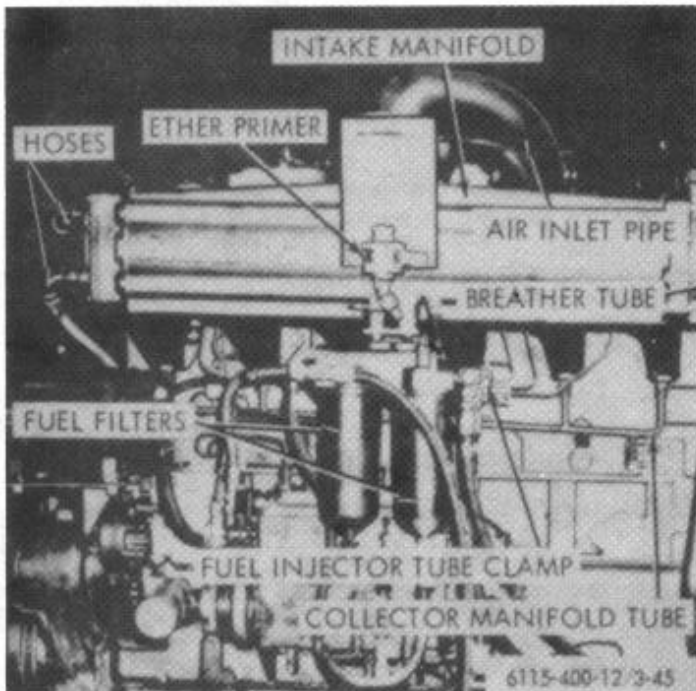
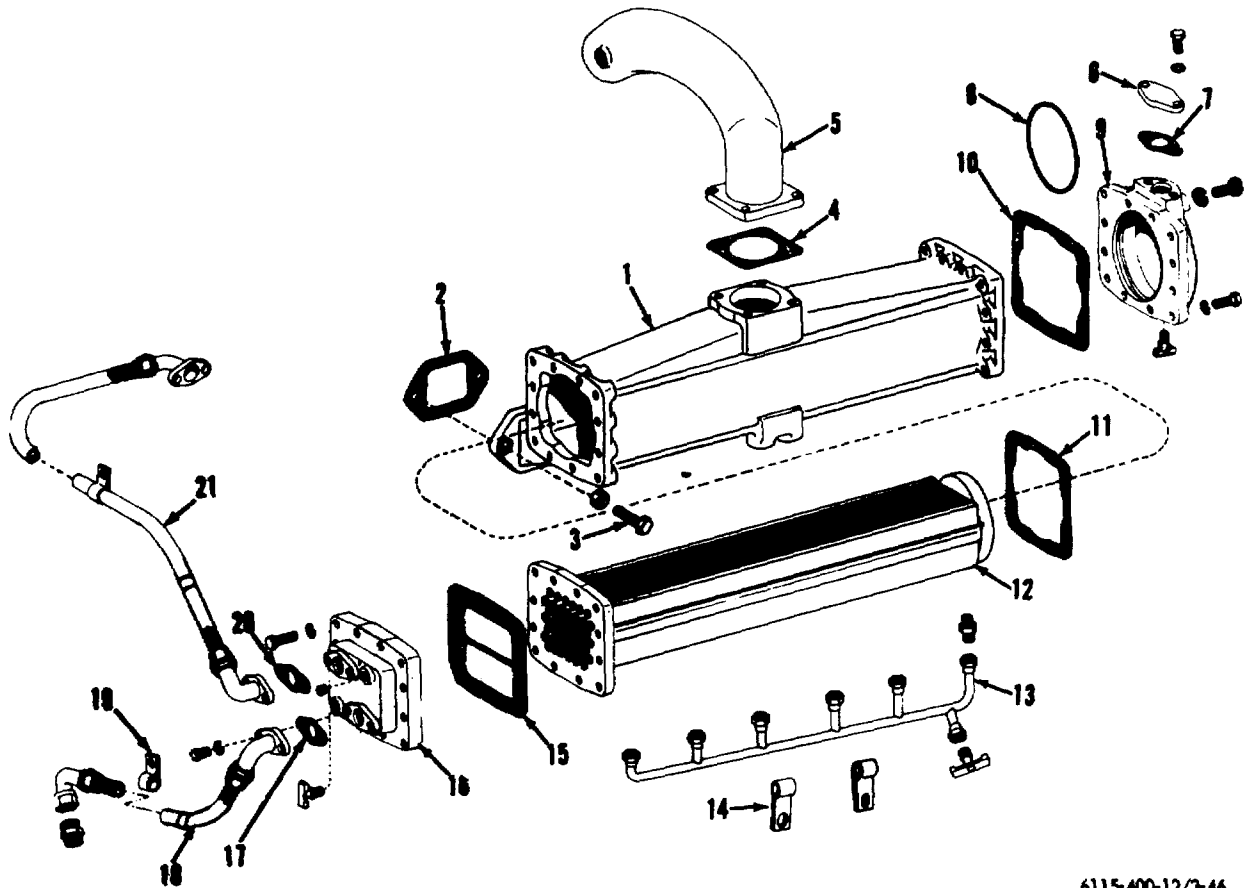

Figure 3-45. Intake manifold, removal and installation.



6115-400-12/3-46

- | | |
|---------------------|-----------------------|
| 1 Manifold | 12 Core assembly |
| 2 Gasket | 13 Collector manifold |
| 3 Capscrew | 14 Clip |
| 4 Gasket | 15 Gasket |
| 5 Elbow | 16 Front bonnet |
| 6 Flange | 17 Gasket |
| 8 Preformed packing | 18 Hose assembly |
| 9 Rear bonnet | 19 Clamp |
| 10 Gasket | 20 Gasket |
| 11 Gasket | 21 Hose assembly |

Figure 3-46. Intake manifold with intercooler, disassembly and reassembly.

- (9) Always use new gaskets and complete the rest of the installation by a direct reversal of the removal procedure. Tighten the intake manifold capscrews to a torque of 68 to 73 foot-pounds.
- (10) Fill the cooling system.
- (11) After the engine is run and the water temperature reaches approximately

180°F., again torque the capscrews to the above value.

3-54. Exhaust Manifold

a. General. Exhaust manifold sections are sealed to each other by means of connecting sleeves, having two seal ring grooves at each end of the sleeves. Manifolds are sealed to the exhaust ports of the heads with steel-

bestos gaskets and secured in place with either nuts and washers or cap screws and washers.

b. *Removal and Installation.* Refer to figure 3-47 and remove manifold.

c. *Exhaust Manifold Reassembly and Installation.*

- (1) Disassemble manifold as required.
- (2) Reassemble and install manifolds in the reverse order of disassembly.

Note. Always use new gaskets when installing the exhaust manifold assembly and when mounting turbocharger. Cement the gaskets to the manifold and let them dry. Install the center section of the three piece manifold first, using two temporary studs

in the cylinder head. The temporary studs are removed after the cap screws are installed. When installing the connecting sleeves and sealing rings, be sure to separate the position of the gaps on the sealing rings to assure a proper seal.

- (3) Tighten the exhaust manifold cap screws to a torque of 68 to 73 foot pounds. After engine is operating and the water temperature reaches approximately 170°F., again torque the cap screws to the specified torque.

3-65. Exhaust Pipe

Refer to figure 3-48 for removal of the exhaust pipe.

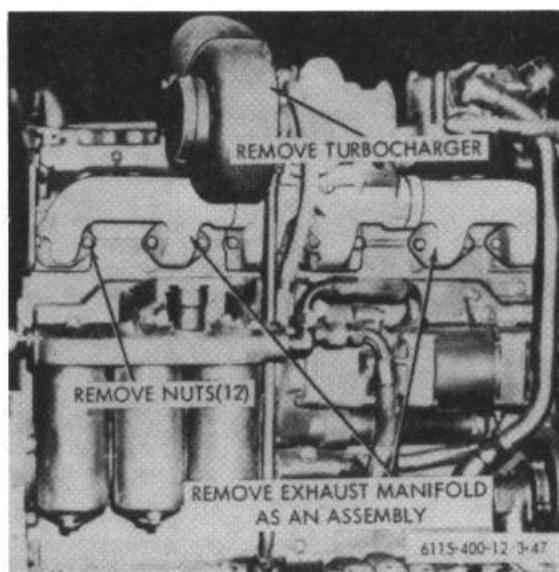

Figure 3-47. Exhaust manifold, removal and installation.

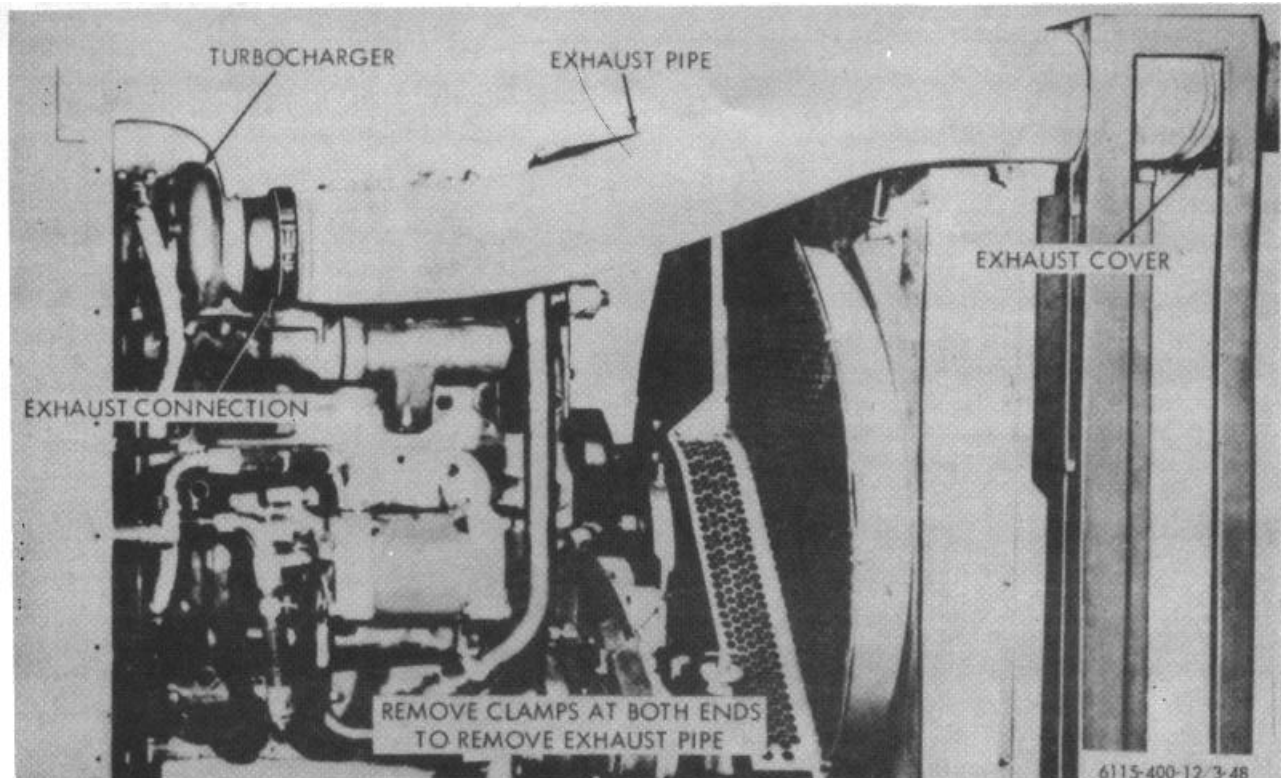

Figure 3-48. Exhaust pipe, removal and installation.

Section XII. ENGINE ELECTRICAL SYSTEM

3-56. Starting Motor and Solenoid Switch

a. On Equipment Testing. Refer to figure 3-49 and test starting motor and solenoid switch.

b. Removal and Installation. Refer to figure 3-50 and remove starting motor and solenoid switch from engine as an assembly.

c. Solenoid Switch Removal. Refer to figure 3-50 and remove solenoid switch from starting motor.

3-57. Generator

a. On Equipment Testing. Refer to figure 3-51 and test generator regulator together as follows:

- (1) Install a suitable adapter between the receptacles of the generator and cabling.
- (2) Start engine (para 2-12).

(3) When a high charging rate with fully charged batteries is indicated, disconnect field jumper. If output remains high, fault is in generator and it must be replaced. If output drops to zero, fault is in generator regulator and it must be adjusted or replaced.

(4) When a low or no-charging rate with partially or fully discharged batteries is indicated, inspect for loose connection or defective wiring. If none, stop engine and disconnect field jumper.

(5) Polarize generator by momentarily connecting a jumper wire between generator field terminal and positive terminal of batteries.

(6) Reconnect field jumper and start engine. If charging rate does not increase as engine speed

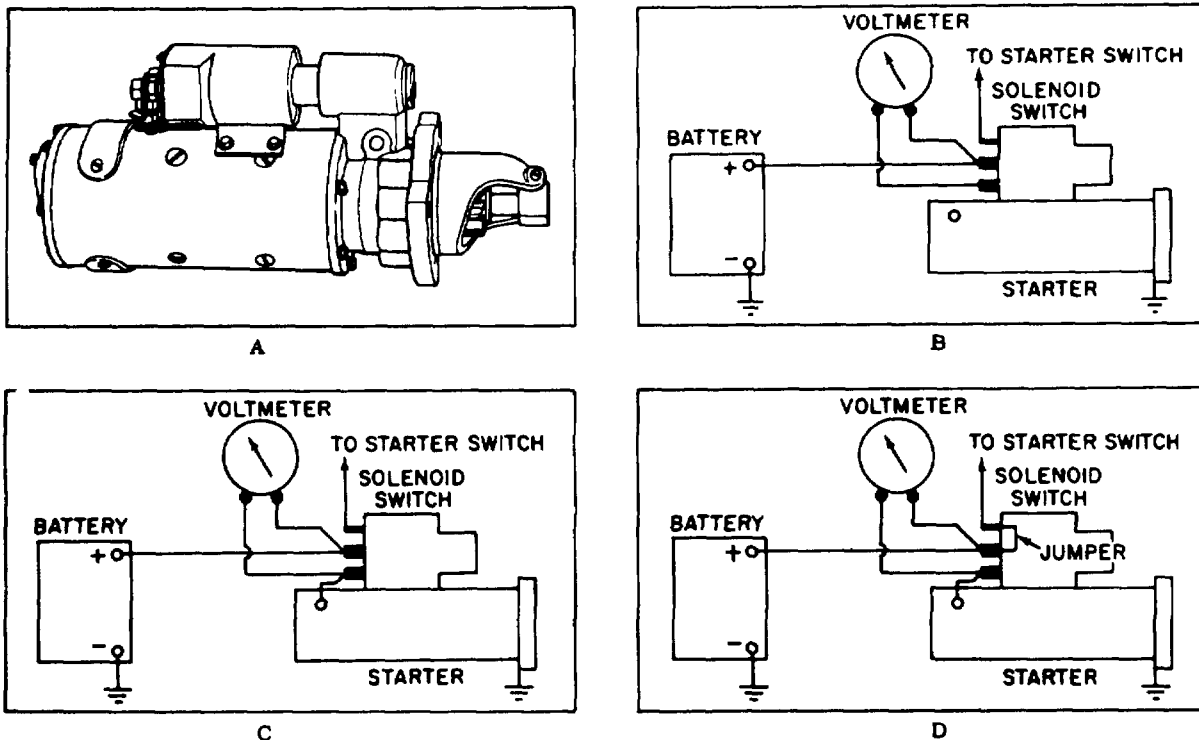

- (1) DETERMINE THAT BATTERY IS FULLY CHARGED AND THAT ALL BATTERY AND STARTER CABLES ARE SERVICEABLE AND PROPERLY INSTALLED.
- (2) REMOVE SOLENOID-TO-STARTER CONNECTOR AND CONNECT VOLTMETER AS SHOWN IN B ABOVE. IF VOLTAGE IS INDICATED, SOLENOID SWITCH IS DEFECTIVE AND MUST BE REPLACED.
- (3) INSTALL THE SOLENOID-TO-STARTER CONNECTOR.
- (4) CONNECT VOLTMETER AS SHOWN IN C ABOVE. IF BATTERY VOLTAGE (24 VOLTS) IS NOT INDICATED, THE STARTER IS DEFECTIVE AND MUST BE REPLACED.
- (5) MOMENTARILY CONNECT A JUMPER AS SHOWN IN D ABOVE. THE VOLTMETER READING SHOULD DROP TO ZERO AND STARTER SHOULD CRANK ENGINE. IF VOLTMETER READING DOES NOT DROP TO ZERO, SOLENOID SWITCH IS DEFECTIVE AND MUST BE REPLACED. IF VOLTMETER READING DROPS TO ZERO BUT STARTER FAILS TO CRANK ENGINE, STARTER IS DEFECTIVE AND MUST BE REPLACED.

6115-400-12/3-49

Figure 3-49. Starting motor and solenoid switch testing.

is increased, stop the engine and connect a jumper wire between armature and field terminals. If charging rate does not increase as engine speed is increased, generator regulator is at fault and must be adjusted or replaced.

Caution: Generator must be polarized whenever leads to generator or generator regulator have been removed or any

adjustment has been made to generator or regulator. Refer to sub-paragraph (5) above to polarize generator. Failure to polarize generator may cause regulator contacts to be damaged by vibration, heavy arcing, and burning.

b. Removal and Installation. Refer to figure 3-52 and remove generator.

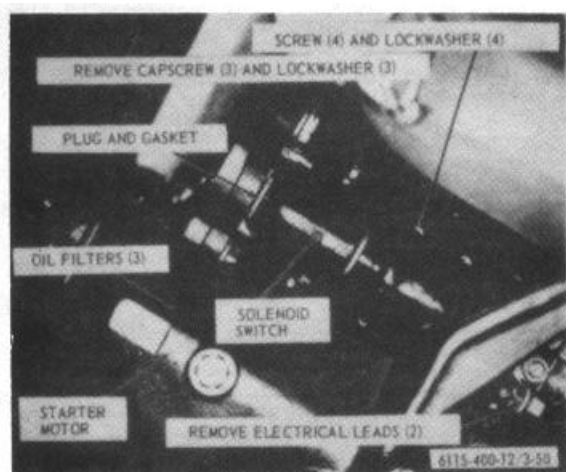

Figure 3-50. Starter motor and solenoid switch, removal and installation.

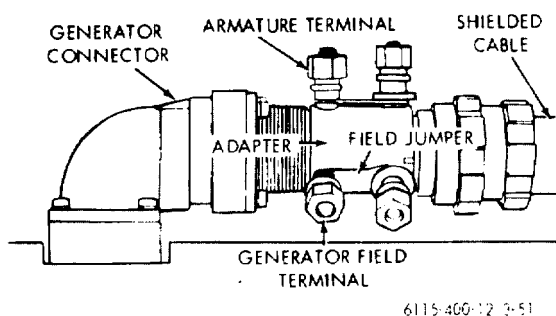
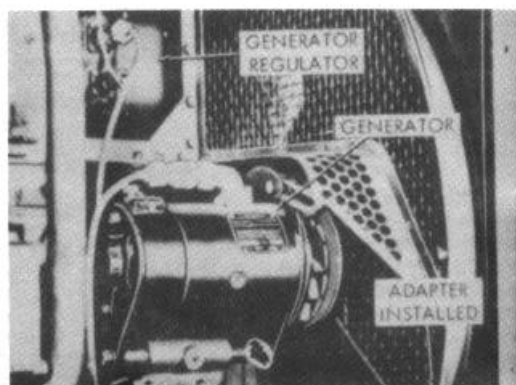

Figure 3-51,. Generator and regulator testing.

c. Service Generator Brushes as Follows:

- (1) Loosen cover band and slide sideways to provide access to brush area.

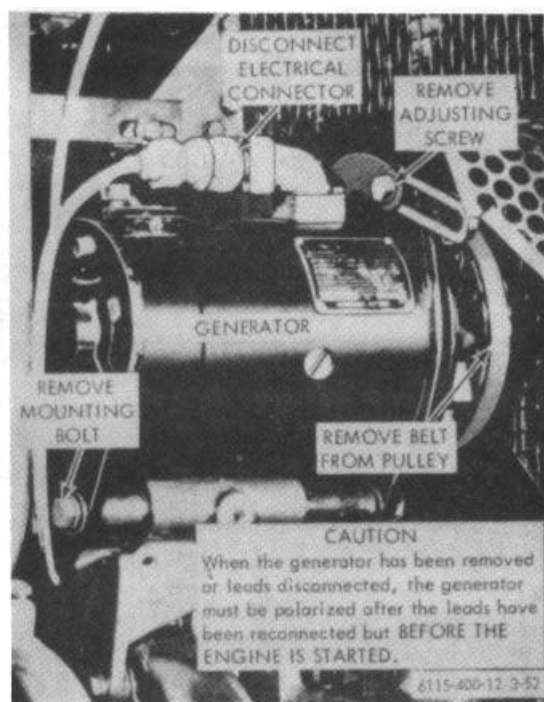

Figure 3-52. Generator, removal and installation.

- (2) Remove screw attaching brush lead to brush holder.
- (3) Remove brush from holder.
- (4) Install new brushes in reverse order of removal.

3-58. Generator Regulator

a. General. The three-unit, heavy-duty generator regulator automatically controls the output of the direct current producing generator to keep the batteries fully charged. A circuit breaker unit closes the circuit between the batteries and the generator when the generator voltage is above the battery voltage and opens the circuit when the condition is reversed. A current regulator unit limits the current to the maximum rated value of the generator. A voltage regulating unit maintains the voltage of the system at the full charge level.

b. Equipment Testing. Refer to paragraph 3-57.

c. Removal and Installation. Refer to figure 3-53 and remove generator regulator.

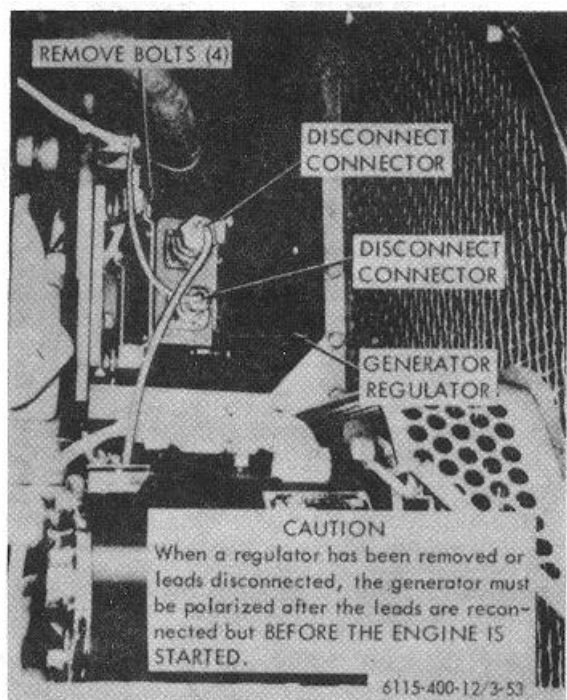

Figure 3-53. Generator regulator, removal and installation.

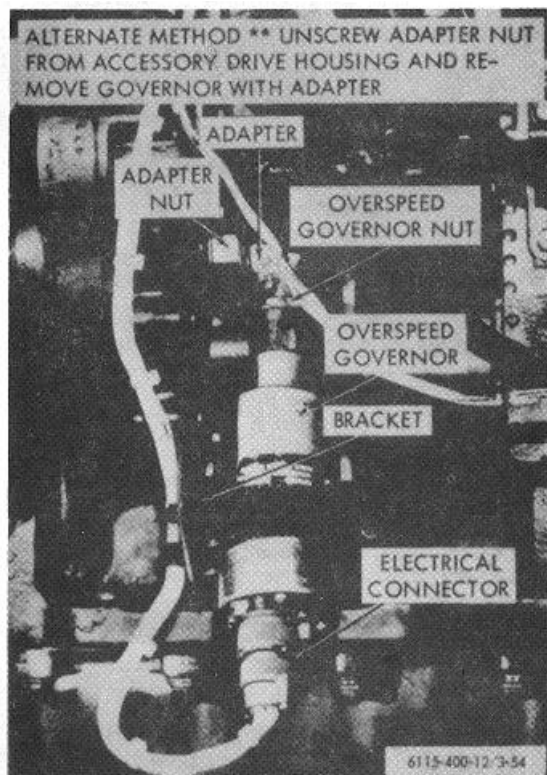

Figure 3-54. Overspeed governor, removal and installation.

3-59. Overspeed Governor

Removal and Installation. Refer to figure 3-54 and remove the overspeed governor.

3-60. Engine Shut-Down Switches

a. Removal and Installation. Refer to figure 3-55 and remove the low oil pressure and high water temperature shutdown switches.

b. Switch Settings.

- (1) The low oil pressure shut-down switch is set to open at 15 psi and to close at 25 psi.
- (2) The high water temperature switch is set to open at 217°F. $\pm 3^\circ\text{F}$, and to close at 205° $\pm 3^\circ\text{F}$.

3-61. Slave Receptacle

Removal and Installation. Refer to figure 3-56 and remove the slave receptacle.

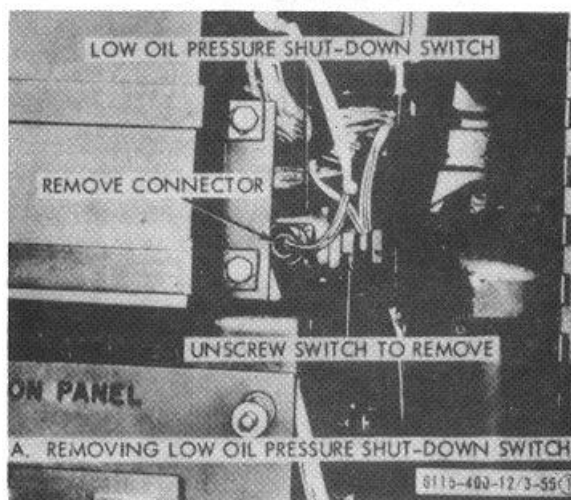

Figure 3-55 (1). Engine shutdown switches, removal and installation.

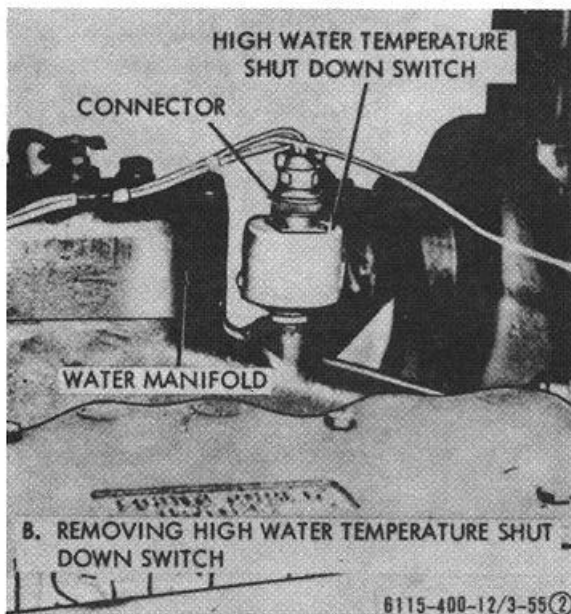

Figure 3-55 (2)Continued.

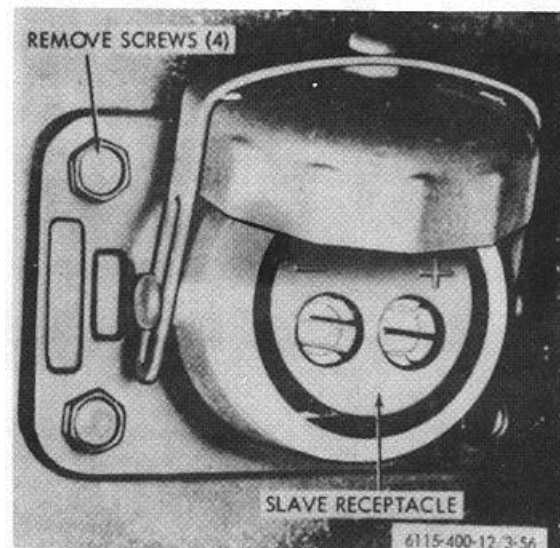

Figure 3-56. Slave receptacles, removal and installation.

3-62. Batteries

a. General. The battery compartment located below the radiator contains four 12 volt batteries connected in series-parallel to provide 24 volt current.

b. Removal and installation. Refer to paragraph 2-4 for removal and installation of batteries.

c. Testing. The battery should be tested with a hydrometer and kept to a specific gravity of 1.250 or above. Always test a battery for degree of charge before adding water. The specific gravity between the cells should be within .025. A dangerously low point of charge indicated by a hydrometer reading of 1.150 or less will permit the battery to freeze at temperatures only a few degrees below the freezing point of water.

A specific gravity of 1.250 will permit the battery to withstand temperatures as low as -65°F. without freezing.

d. *Water : Addition.* The electrolyte level should be maintained 3/8 inch above the separators or insulators by addition of distilled water or "approved water" (water free from impurities by analysis). Do not overfill or under fill the cells of the battery as either has a detrimental effect on battery life.

Note. Use of a mirror is recommended when checking electrolyte level in batteries.

e. Charging. The charging rate is correct when the battery maintains a minimum specific gravity of 1.250 and does not require the addition of more than 1 ounce of water per cell per week or 50 service hours.

Section XIII. ENGINE CONTROLS AND INSTRUMENTS

3-63. Battery-Charging Ammeter

Removal and Installation. Refer to figure 3-57 and remove the battery-charging ammeter.

3-64. Time Totalizing Meter

Removal and Installation. Refer to figure 3-57 and remove the totalizing meter.

3-65. Gages

Removal and Installation. Refer to figure 3-57 for removal of the fuel level gage, coolant temperature gage, and the engine oil pressure gage.

3-66. Engine Control Switches

Removal and Installation. Refer to figure 3-57 for removal of the engine primer switch and the engine start-run-stop switch.

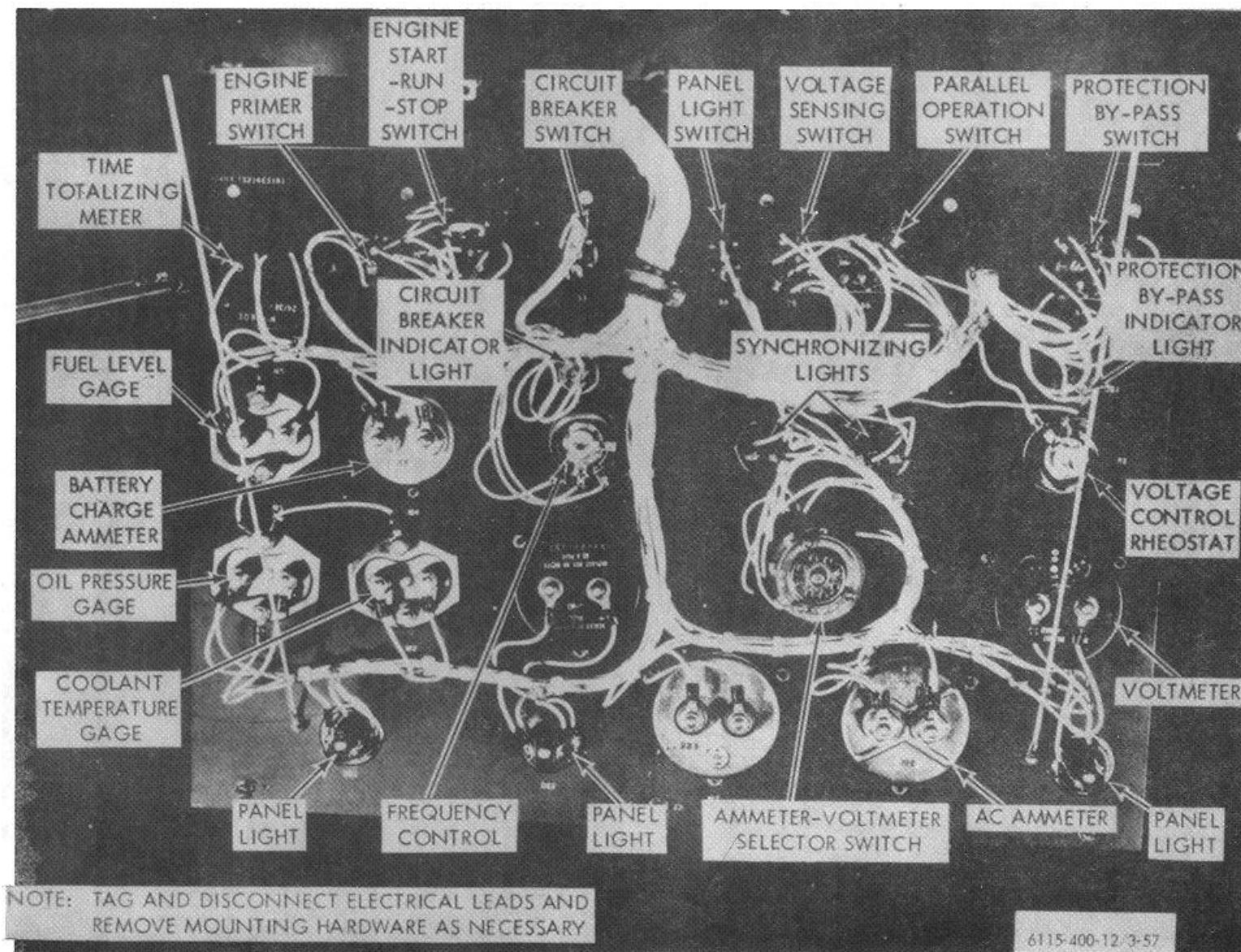

Figure 3-57. Controls and instruments, removal and installation.

Section XIV. GENERATOR CONTROLS AND INSTRUMENTS

3-67. Wiring

a. *General.* The wiring diagram (fig. 1-3) should be consulted when work on the electrical system is necessary.

Caution: As a precaution against short circuits, disconnect the battery ground cable from the batteries before inspecting, testing or replacing any wiring.

b. Inspection.

- (1) Remove any dust and dirt from the wiring with a clean, dry cloth.
- (2) Inspect the insulation for cracks, breaks, or fraying. Pay particular attention to places where wires pass through holes or over rough edges. Wrap cracked or frayed areas with an approved electrical tape. Repair or replace a defective wire.
- (3) Inspect the terminals for cracks, splits, and corrosion. Replace a defective terminal.

c. Testing. To test a wire for continuity, disconnect each end of the wire from the component to which it is attached. Touch the probes of a multimeter to each end of the wire. If continuity is not indicated, the wire is defective and must be replaced.

d. Repair.

- (1) If a broken wire is accessible, remove sufficient insulation from each side of the break to allow a good connection of the bared ends by twisting them together. Solder the connection and wrap with electrical tape.
- (2) If a wire is broken from a terminal connector, replace the connector.

Caution: Under no condition, leave the bare connection exposed.

- (3) If a break in the wire is inaccessible and the wire is not part of a wiring harness, disconnect and remove it. Connect a new

wire of the same gage and insulation to the proper terminals. Refer to the wiring diagram (fig. 1-3) and properly tag both ends of all replacement wires. Always replace any braided shielding removed from wiring or cables during repair of electrical systems.

Caution: Do not pull the cable or twist the braided shielding of cables having braided metal covering. Carefully work the cable from side to side until the braided shielding is sufficiently loose to allow removal of the cable.

3-68. AC Ammeter

Removal and Installation. Refer to figure 3-57 and remove the ac ammeter.

3-69. Voltmeter

Removal and Installation. Refer to figure 3-57 and remove the voltmeter.

3-70. Ammeter-Voltmeter Selector Switch

Removal and Installation. Refer to figure 3-57 and remove the ammeter-voltmeter selector switch.

3-71. Frequency Control Rheostat

Removal and Installation. Refer to figure 3-57 and remove the frequency control rheostat.

3-72. Voltage Control Rheostat

Removal and Installation. Refer to figure 3-57 and remove the voltage control rheostat.

3-73. Switches

Removal and Installation. Refer to figure 3-57 for removal of the ac circuit breaker switch, panel light switch, voltage sensing switch, parallel operation switch, or the protection bypass switch.

3-74. Fault Indicator Panel

Removal and Installation. Refer to figure 3-58 for removal of the fault indicator panel.

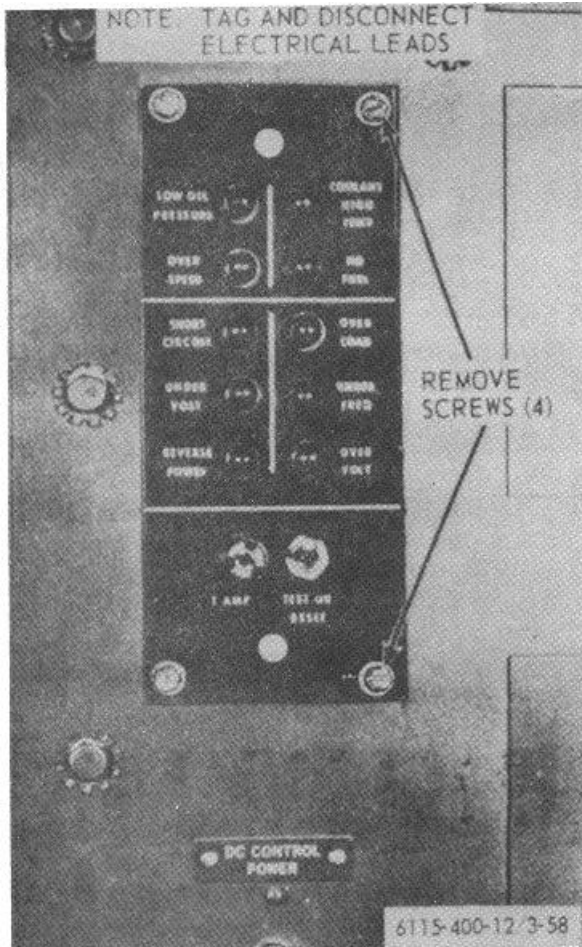

Figure 3-58. Fault indicator panel, removal and installation.

3-78. Electrical Governor Control Unit

Removal and Installation. Refer to figure 3-60 and remove the electric governor control unit and plug-in elements.

Note. Direct and general support maintenance personnel will make adjustments.

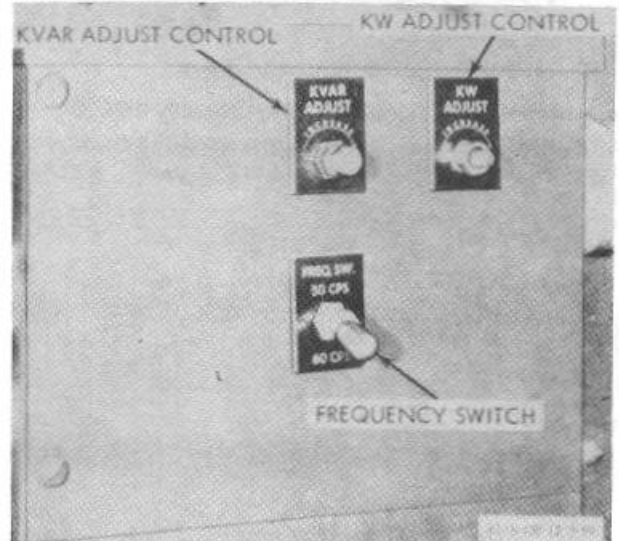

Figure 3-59. KVAR adjust control , removal and installation

3-75. KVAR Adjust Control

Removal and Installation. Refer to figure 3-59 and remove the KVAR adjust control. Tag and disconnect electrical leads and remove mounting hardware.

3-76. KW Adjust Control

Removal and Installation. Refer to figure 3-59 and remove the KW adjust control. Tag and disconnect the electrical leads.

3-77. Frequency Switch

Removal and Installation. Refer to figure 3-59 and remove the frequency switch. Tag and disconnect the electrical leads.

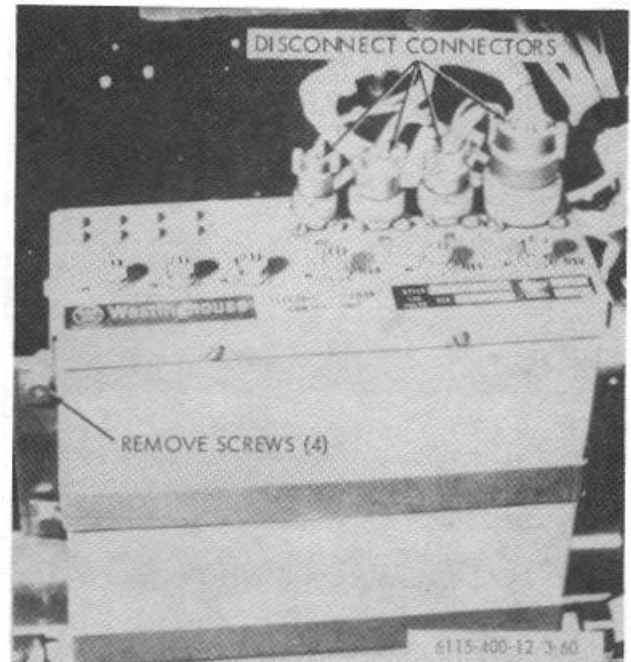

Figure 3-60. Electric governor control unit, removal and installation.

Section XV. FRAME AND HOUSING**3-79. Ground Stud**

Removal and Installation. Refer to figure 3-61 and remove ground stud.

Note. Be sure the base is clean for good electrical contact before installing ground stud.

3-83. Housing, Panels, and Doors

Removal and Installation. Refer to figure 3-62 and remove the housing components.

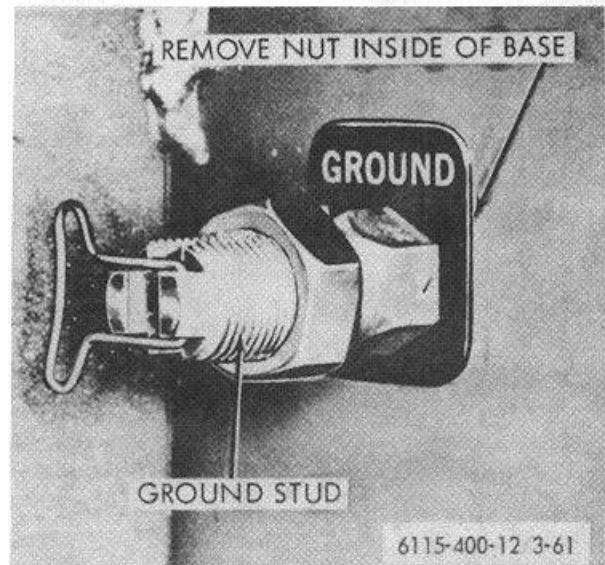

Figure 3-61. Ground stud, removal and installation

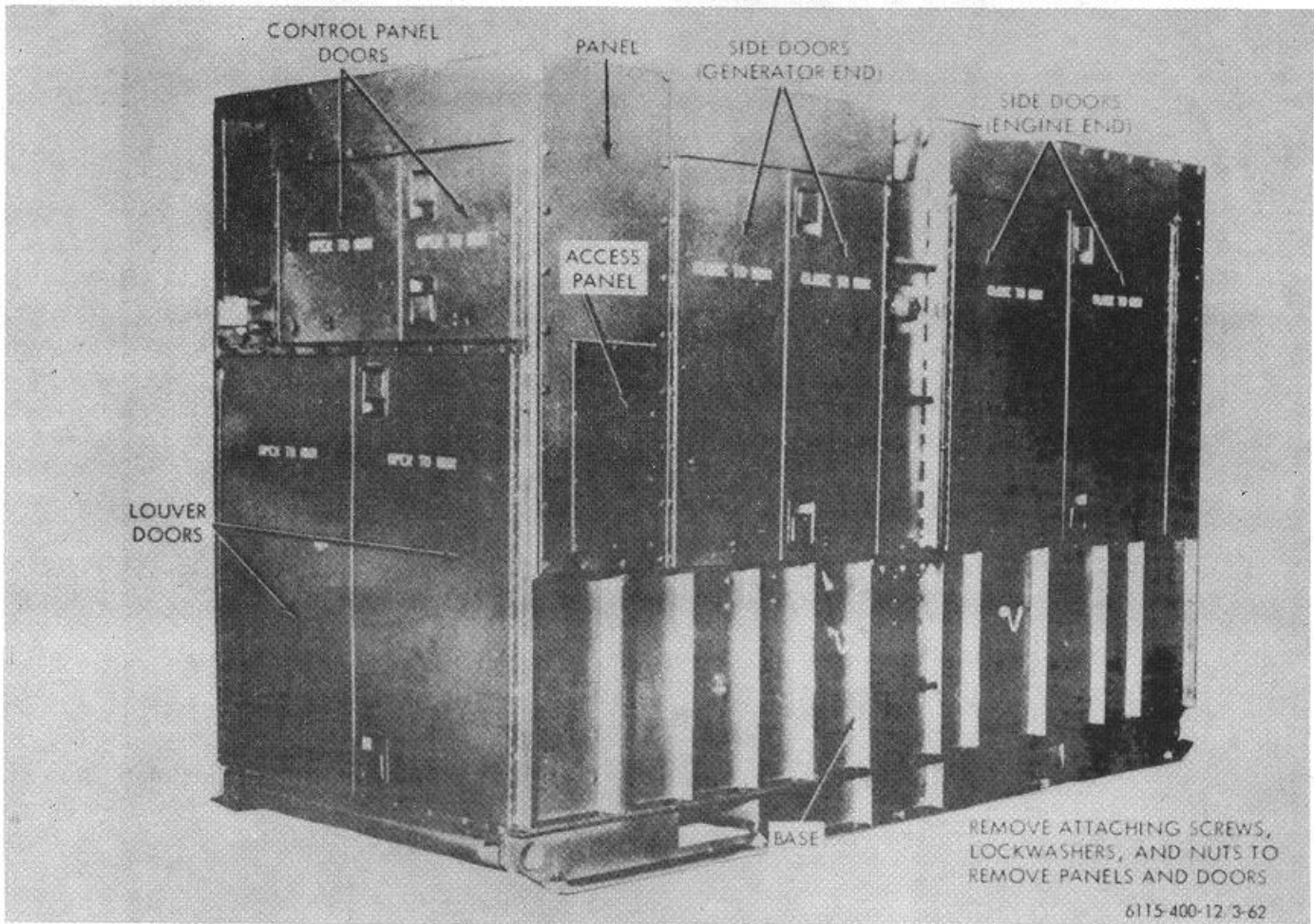

Figure 3-62. Housing, panels, and doors, removal and installation.

Section XVI. GENERATOR

3-81. General

This section contains information on the maintenance of the main generator which is the responsibility of organizational maintenance. This includes the main generator covers and brushes.

3-82. Main Generator Brushes

a. Removal and Installation.

- (1) Remove the main generator cover (fig. 3-63).
- (2) Remove the main generator brushes (fig. 3-63).

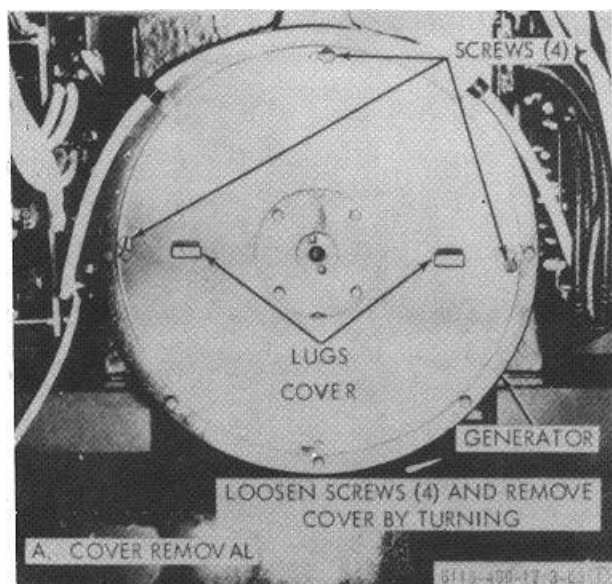

Figure 3-63 (1). Main generator brushes, removal and installation.

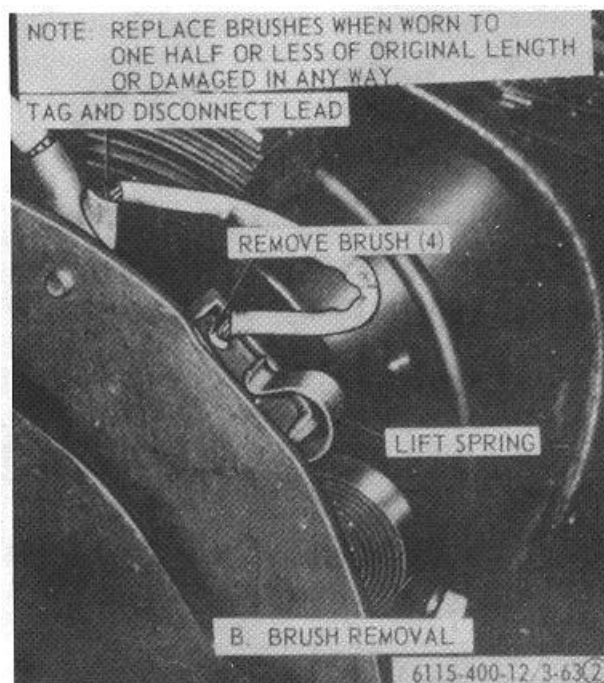

Figure 3-63 (2)--Continued.

Section XVII. WINTERIZATION EQUIPMENT

3-83. General

Winterization equipment, for starting the engine when temperatures are below -25°F ., consists of two kits as follows:

a. A generator set kit including two heaters, coolant lines, fuel line, electrical controls, and mounting hardware to be installed in the set for preheating the engine oil pan and cooling system. The heaters are designed to use a variety of fuels and can be operated on any fuel available from the diesel engine fuel system.

b. A portable auxiliary winterization kit is also available to provide separate heated and charged batteries. This kit includes a heater for heating the auxiliary batteries and a battery charger which can be connected to any

110V, 50/60 or 400 CPS power supply. Refer to supplement to this manual for operation and maintenance of this auxiliary kit.

3-84. Heaters

a. *Removal and Installation.*

Refer to figure 3-64 and remove heaters as follows:

- (1) Turn fuel valve to OFF position.
- (2) Turn both coolant valves to OFF position.
- (3) Disconnect electrical connectors from heaters.
- (4) Disconnect fuel line from heater.
- (5) Disconnect coolant lines from heater.
- (6) Remove mounting clamps and remove heaters.

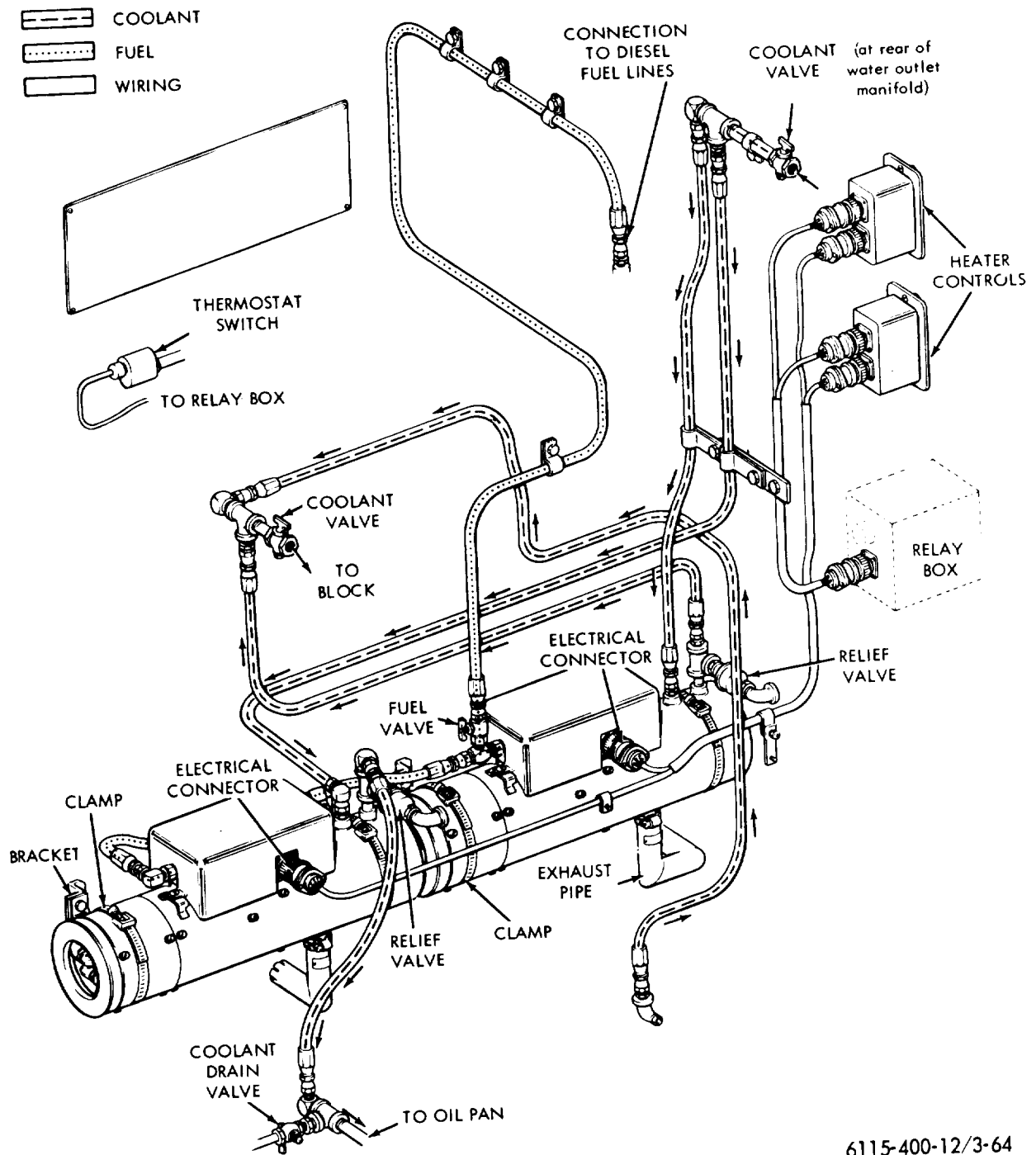

6115-400-12/3-64

Figure 3-64. Heaters, removal and installation.

CHAPTER 4

SHIPMENT AND LIMITED STORAGE AND DEMOLITION TO
PREVENT ENEMY USE

Section I. SHIPMENT AND LIMITED STORAGE

4-1. Preparation of Equipment for Shipment

a. General. Detailed instructions for the preparation of the generator for domestic shipment are outlined within this paragraph. Preservation will be accomplished in sequence that will not require the operation of previously preserved components.

b. Inspection. The generator will be inspected for any unusual conditions such as damage, rusting, accumulation of water, and pilferage. Inspection of the individual components and assemblies will be as outlined on "Preventive Maintenance Checks and Services, Quarterly" in this manual.

c. Cleaning and Drying. Clean all surfaces of the generator with approved cleaning solvent and dry thoroughly. Refer to TM 38230.

d. Painting. Remove rust and corrosion from areas to be painted by sanding. Paint the exposed and sanded surfaces. (TM 9-213).

e. Depreservation Guide. DA Form 2258 (Depreservation Guide for Vehicles and Equipment).

- (1) A properly annotated depreservation guide will be completed concurrently with preservation for each item of mechanical equipment. Any peculiar requirements will be outlined in the blank space on the form. The completed depreservation guide will be placed with the equipment in a waterproof envelope marked "depreservation Guide," and fastened in a conspicuous location on or near the operator's controls.

- (2) Prior to placing equipment in operation or to the extent necessary for inspection, depreservation of the item will be performed as outlined on the depreservation guide.

f. Power Cable. The power cable will be disconnected, coiled, and tied securely to the metal frame inside the cabinet. The access panel will then be reinstalled and the cable opening sealed with tape.

g. Basic Issue Items. All basic issue items will be packed with the publications and made secure.

Note

If packing is required o provide adequate probation against damage during shipment, rear to TM 38-230 for guidance in crate fabrication.

4-2. Loading Equipment for Shipment

Use appropriate materials handling equipment of sufficient capacity to lift the generator onto the carrier. Block and tie the unit to the carrier to assure that it will not move during transit.

4-3. Preparation of Equipment for Limited Storage

a. Detailed instructions for preparation of the generator for limited storage are provided in paragraph 3-83. Limited storage is defined as storage not to exceed six (6) months. Refer to AR 743-505.

b. Every effort should be made to provide covered storage for the generator. If this is

impossible, select a firm, level, well-drained storage location, protected from prevailing winds. Position the generator on heavy planking, cover with a tarpaulin or other suitable waterproof covering. Secure in a manner that will provide the generator maximum protection from the elements.

4-4. Inspection and Maintenance of Equipment in Limited Storage

Every 90 days, the generator will be inspected as outlined in "Preventive Maintenance Checks and Services, Quarterly." After each inspection period, the generator will be represerved as outlined in paragraph 4-3.

Section II. DEMOLITION OF MATERIEL TO PREVENT ENEMY USE

4-5. General

When capture or abandonment of the generator is imminent, the responsible unit commander must make the decision either to destroy the equipment or to render it inoperative. Based on this decision, orders are issued which cover the desired extent of demolition. Whatever method of demolition is employed, it is essential to destroy the same vital parts of generator and all corresponding repair parts. When the lack of time or personnel prevents complete destruction of the equipment, the following priorities will be used in the demolition of essential parts. Priorities for demolition:

Priorities	Parts
1.....	Electrical system
2.....	Engine
3.....	Control panels
4.....	Tubing
5.....	Cables and wiring

4-6. Demolition to Render the Equipment Inoperative

a. Demolition by Mechanical Means. Use sledge hammers, crowbars, picks, axes, or any other heavy tools which may be available. Strike all vital parts repeatedly until completely destroyed.

b. Demolition by Misuse. Perform the following steps to render the generator inoperative.

- (1) Drain engine oil and run engine at full capacity until engine stops.
- (2) Bend fan blades housing to prevent fan blades from turning.

4-7. Demolition by Explosive or Weapons Fire

a. Explosive. Place as many of the charges as the situation permits, and detonate them 4-2 simultaneously with a detonating cord and a suitable detonator.

b. Weapons fire. Fire on the generator, using the heaviest practical weapon available.

4-8. Other Demolition Methods

a. Scattering and Concealment. Remove all easily accessible parts and wiring, and scatter them through dense foliage, bury them, or throw them in body of water. Make certain of complete submersion.

b. Burning. Pack rags, clothing, or paper under and around the generator. Saturate this packing with gasoline, oil, or diesel fuel, and ignite.

c. Submersion. Completely submerge the generator in a body of water to provide water damage and concealment. Salt water does greater damage to metal parts than fresh water.

4-9. Training

All operators should receive thorough training in the demolition of the generator. Refer to FM 5-25. Simulated demolition using all of the methods listed above should be included in the operator-training program. It must be emphasized, in training, that demolition operations are usually necessitated by critical situations when time available for carrying out demolition is limited. For this reason, operators must be thoroughly familiar with all methods of demolition of equipment and must be able to carry out demolition instructions without reference to this or any other manual.

APPENDIX A**REFERENCES**

A-1. Fire ProtectionTM 5-4200-200-
10

Hand Portable Fire Extinguisher for Army Use

A-2. LubricationLO 5-6115-400-
12Lubrication Order for Generator Set, Allis-Chalmers, 25,000 (MIL Mod.
SF 200MD/CIED)**A-3. Preventive Maintenance**TM 38-750
TM 9-6140-200-
15
TM 5-764The Army Equipment Record System and Procedures
Storage Batteries, Lead Acid Type

Electric Motor and Generator Repair

A-4. Radio Interference Suppression

TM 11-483

Radio Interference Suppression

A-5. Supply Publication

C 9100 IL

Petroleum, Petroleum Base Products and Related Materials

A-6. PreservationTM 38-230
TM 9-213Preservation Packaging and Packing of Military Supplies and Equipment
Painting Instructions for Field Use

APPENDIX B

BASIC ISSUE ITEMS LIST

Section I. INTRODUCTION

B-1. Scope

This appendix lists items which accompany the Generator Set or are required for installation, operation, or operator's maintenance.

(2) Maintenance Code indicates the lowest category of maintenance authorized to install the listed item. The maintenance level code is:

B-2. General

This Basic Issue Items List is divided into the following sections:

a. Basic Issue Items-Section II. This section is a listing of accessories, repair parts, tools, and publications required for operator's maintenance and operation, initially issued with, or authorized for the Generator Set.

b. Maintenance and Operating Supplies Section III. This section is a listing of maintenance and operating supplies required for initial operation.

B-3. Explanation of Columns

The following provides an explanation of columns in the tabular list of Basic Issue Items, Section II:

a. Source, Maintenance, and Recoverability Codes (SMR), Column 1:

(1) Source Code indicates the selection status and source for the listed item. Source codes are:

Code	Explanation
P	Applied to repair parts which are stocked in or supplied from GSA/DSA Army supply, and authorized for use at indicated maintenance categories.
M	Applied to repair parts which are not procured or stocked but are to be manufactured at indicated maintenance categories.

Code	Explanation
C	Operator/crew

(3) Recoverability Code indicates whether unserviceable items should be returned for recovery or salvage. Items not coded are expendable.

b. Federal Stock Number, Column 2. This column indicates the Federal stock number for the item.

c. Description, Column 3. This column indicates the Federal item name and any additional description required. A five-digit manufacturer's or other service code is shown in parentheses followed by the manufacturer's part number. Repair parts quantities included in kits, sets, and assemblies that differ from the actual quantity used in the specific item, are listed in parentheses following the repair part name.

d. Unit of Issue, Column 4. This column indicates the unit used as a basis of issue, e.g., ea, pr, ft, yd, etc.

e. Quantity Incorporated in Unit Pack, Column 5. This column indicates the actual quantity contained in the unit pack.

f. Quantity Incorporated in Unit, Column 6. This column indicates the quantity of the item used in the equipment.

g. Quantity Furnished With Equipment, Column 7. This column indicates the quantity of an item furnished with the equipment in excess of the quantity incorporated in the unit.

h. Quantity Authorized, Column 8. This column indicates the quantity of an item authorized the operator/crew to have on hand or

to obtain as required. As required items are indicated with an asterisk.

i. Illustration, Column 9. This column is divided as follows:

- (1) Figure Number, column 9a, indicates the figure number of the illustration in which the item is shown.
- (2) Item Number, column 9b, indicates the callout number used to reference the item in the illustration.

B-4. Explanation of Columns in the Tabular List of Maintenance and Operating Supplies - Section III

a. Item, Column 1. This column contains numerical sequence item numbers assigned to each component application to facilitate reference.

b. Component Application, Column 2. This column identifies the component application of each maintenance or operating supply item.

c. Federal Stock Number, Column 3. This column indicates the Federal stock number for the item and will be used for requisitioning purposes.

d. Description, Column 4. This column indicates the item and a brief description.

e. Quantity Required for Initial Operation, Column 5. This column indicates the quantity of each maintenance or operating supply item required for initial operation of the equipment.

f. Quantity Required for Eight Hours Operation, Column 6. This column indicates the estimated quantities required for an average eight hours of operation.

g. Notes, Column 7. This column indicates informative notes keyed to data appearing in a preceding column.

Section II. BASIC ISSUE ITEMS

(1) SMR Code	(2) Federal Stock Number	(3) Description Ref No. & Mfr Code Usable on Code		(4) Unit of issue	(5) Qty inc in unit pack	(6) Qty inc in unit	(7) Qty furn with equip	(8) Qty auth	(9) Illustration	
									(a) Fig No.	(b) Item No.
POR	6140 57-2554	GROUP 31--Basic Issue Items Manufacturer or Depot Installed 3100--Basic Issue Items Manufacturer or Depot Installed Battery, Storage, Repair Parts Manual Group 0612		EA			4	4		
PO	7510-889-3494	Binder Log Book					1	1		
PO	7520-559-9618	Case, Maintenance and Operational Manuals Cotton Duck Water Repellent Mildew Resistant					1	1		
PO	6810-264-9063	SULPHURIC ACID: Electrolyte Group 32 32 Basic Issue Items Troop Installed or Authorized		GAL						
PO	5975443-5861	CLAMP, ELECTRICAL: ground rod, 1/2 to 1 in. id (GE)						1		
PO	512W0223-7296	PLIERS: slip joint straight nose combination w/cutters 6 in. lg					*	1		
PO	597-642-837	ROD, GROUND: 9 ft. lg., 5/8 in. in diameter con point					*	1		
PO	5120-277-9491	SCREWDRIVER, FLAT TIP: wood handle 1/4 in. flared tip, 4 in. lg. blade					*	1		
PO	51e2222-881	SCREWDRIVER, FLAT TIP: flared tip, metal with wood insert handle, 7/16 tip w/8 in. blade length					*	1		
PO	5120-24-5328	WRENCH, OPEN END ADJUSTABLE: single head 0.947 in. jaw opening, 8 in. lg.					*	1		
PO	5120-2643796	WRENCH, OPEN END ADJUSTABLE: 0 to 1.322 in. jaw opened 12 in. lg.					*	1		
MO		WIRE, ELECTRICAL: Manufacturer From:								
PO	6145- 35-9433	WIRE, ELECTRICAL: No. 4 AWG (10 ft. required) GROUP 76		FT			*	10		
PO	4120558837	7603--Fire Extinguisher FIRE EXTINGUISHER, MONOBROMOTRIFLUOROMETHANE: 2.75 lbs. (GE) (Repair Parts Manual Group 7603)					1	1		

Section III. MAINTENANCE AND OPERATING SUPPLIES

Item	Component Application	Federal Stock No.	Description	Quantity required for initial operation	Quantity required for 8 hours operation	Notes
1	0101 Crankcase		OIL, LUBRICATING: 55 gallon drums as follows:			1. Includes quantity of oil to fill crankcase, lines and filter. 2. Tank Capacity. 3. Governor capacity. 4. Radiator capacity 5. Refer to freezing points for mixture.
		9150-680-1106	HDO 30k	44 Qt (1)		
		9150-680-1103	HDO 10	44 Qt (1)		
2	0306 Fuel Tank	9150-242-7604	Arctic (OES)	44 Qt (1)		
			FUEL, DIESEL 55 gallon drums as follows:			
		9140-286-5294	DF-2	200 Gal (2)	127 Gal	
		9140-286-5288	DF-1	200 Gal (2)	127 Gal	
		9140-286-5284	DF-A	200 Gal (2)	127 Gal	
3	0308 Governor		OIL, HYDRAULIC: one Gallon Can			
		9150-223-4134	OHA	8 Qt (3)		
4	0501 Radiator		ANTIFREEZE: 55 gallon drums as follows:			
		6858-934-8636	Ethylene Glycol (5)	70 Qt (4)		
		6850-174-1806	Arctic	70 Qt (4)		

APPENDIX C

MAINTENANCE ALLOCATION CHART

C-1. General

a. This section provides a general explanation of all maintenance and repair functions authorized at various maintenance level

b. Section II designates overall responsibility for the performance of maintenance options on the identified end item or component. The implementation of the maintenance tasks upon the end item or component will be consistent with the assigned maintenance operations.

c. Section III normally lists special tools or equipment required to perform maintenance functions on the equipment, no special tools or equipment are required for this equipment.

d. Section IV normally indicates special instructions pertinent to tooling, no special instructions are required.

C-2. Explanation of Columns In Section. II

a. *Functional Group Number.* The functional group is a numerical group set up on a functional basis. The applicable functional grouping indexes (obtained from TB 75093-1, Functional Grouping Codes) are listed on the Maintenance Assignment in the appropriate numerical sequence. These indexes are normally set up in accordance with their function and proximity to each other.

b. *Component Assembly Nomenclature.* This column contains a brief description of the components of each functional group.

c. *Maintenance Functions.* This column lists the various maintenance functions (A through K) and indicates the lowest maintenance category authorized to perform these operations. The symbol designations for the various maintenance categories are as follows:

- C - Operator or crew
- O - Organizational maintenance
- F - Direct support maintenance
- H - General support maintenance

D - Depot maintenance

The maintenance functions are defined as follows:

- A - INSPECT: Verify serviceability and detect incipient electrical or mechanical failure by close visual examination.
- B - TEST: Verify serviceability and detect incipient electrical or mechanical failure by measuring the mechanical or electrical characteristics of the item and comparing those characteristic with authorized standards. Tests will be made commensurate with test procedures and with calibrated tools and/or test equipment referenced in the Maintenance Assignment.
- C - SERVICE: Operations required periodically to keep the item in proper operating condition, i.e., to clean, preserve, drain, paint, and replenish fuel, lubricants, hydraulic, and deicing fluids, or compressed air supplies.
- D - ADJUST: Regulate periodically to prevent malfunction. Adjustments will be made commensurate with adjustment procedures and associated equipment adjustment specifications.
- E - ALINE: Adjust two or more components of an electrical or mechanical system so that their functions are properly synchronized or adjusted.

- F- CALIBRATE: Determine, check, or rectify the graduation of an instrument, weapon, or weapons system or components of a weapon item.
- G - INSTALL: Remove and install the same item for service or when required for the performance of other maintenance operation.
- H - REPLACE: Substitute serviceable components, assemblies and subassemblies for unserviceable counterparts.
- I - REPAIR: Restore to a serviceable condition by replacing unserviceable parts or by any other action required using available tools, equipment and skills, including welding, grinding, riveting, straightening, adjusting and facing.
- J - OVERHAUL: Restore an item to a completely serviceable condition (a prescribed by serviceability standards developed and published by the commodity commands) by employing techniques of Inspect and Repair Only As Necessary (IROAN). Maximum of diagnostic and test equipment is combined with minimum disassembly during overhaul. "Overhaul" may be assigned to any level of maintenance except organizational, provided the time, tools, equipment, repair parts authorization, and technical skills are available at that level. Normally, overhaul as applied to end items, is limited to depot maintenance level.
- K - REBUILD: Restore to a condition comparable to new by disassembling to determine the condition of each component part and reassembling

using serviceable, rebuilt or new assemblies, subassemblies, and parts.

L - TOOLS AND EQUIPMENT: No special tools or equipment are required to perform maintenance on the generator set.

M - REMARKS: Not applicable.

C-3. Explanation of Columns in Section III

a. *Reference Code.* This column consists of a number and a letter separated by a dash. The number references the Tools and equipment requirements column on the Maintenance Assignment. The letter represents the specific maintenance function the item is to be used with. The letter is representative of columns A through K on the Maintenance Assignment.

b. *Maintenance Level.* This column shows the lowest level of maintenance authorized to use the special tool or test equipment.

c. *Nomenclature.* This column lists the name or identification of the tool or test equipment.

d. *Tool Number.* This column lists the manufacturer's code and part number, or Federal stock number of tools and test equipment.

C-4. Explanation of Columns in Section IV

a. *Reference Code.* This column consists of two letters separated by a dash, both of which are references to Section II. The first letter references column 5 and the second letter references a maintenance function, column 3, A through K.

b. *Remarks.* This column lists information pertinent to the maintenance function being performed, as indicated on the Maintenance Assignment, Section II.

Section II. MAINTENANCE ASSIGNMENT

GROUP NUMBER	Component assembly nomenclature	Maintenance functions										Note reference		
		A	B	C	D	E	F	G	H	I	J	K	L	M
		INSPECT	TEST	SERVICE	ADJUST	ALIGN	CALIBRATE	INSTALL	REPLACE	REPAIR	OVERHAUL	REBUILD	Tools and equipment	Remarks
01	ENGINE													
0100	Engine Assembly: Engine, diesel	C	F	C					F	F	H			
	Bracket mounting							F						
0101	Crankcase, Cylinder Head: Crankcase							H	H					
	Head, cylinder							F	F					
0102	Crankshaft: Bearings							H						
	Crankshaft							H		D				
	Pulley							F						
	Seals							F						
	Damper, vibration							F						
0103	Flywheel: Flywheel assembly							F	H					
	Cover, dust -							O						
0104	Pistons, Connecting Rod: Piston assembly							H	H					
	Rod assembly							H	H					
0105	Valves, Camshafts, Timing System Arms, rocker				O			F						
	Cover, valve							O						
	Guide, valve							O						
	Insert, valve seat							F	F					
	Valve, poppet							F	F					
	Rod, push							F						
	Lifter, valve							F						
	Bearings, camshaft							H						
	Camshaft							H						
	Gears, helical							H						
	Washer, thrust							H						
	Cover, gears							H						
0106	Engine Lubrication System: Breather			C				O						
	Gage, oil level			C				O						
	Filter assembly, oil			C				O						
	Valve, relief oil filter							O						
	Cooler, oil							O						
	Pump assembly, oil							F	F					
	Pan, oil -							F						
	Lines, oil -	C						O						
0108	Manifolds Manifold, intake and exhaust							O						
03	FUEL SYSTEM													
0301	Fuel Injector: Fuel injector				F			O	F					
0302	Fuel Pumps: Pump, fuel transfer			O				O						
	Pump, fuel injection		H		O			O	F	H				
0304	Air Cleaner: Cleaner, assembly, air			C				O						

Section II. MAINTENANCE ASSIGNMENT

GROUP NUMBER	Component assembly nomenclature	Maintenance functions										Note reference		
		A	B	C	D	E	F	G	H	I	J	K	L	M
		INSPECT	TEST	SERVICE	ADJUST	ALIGN	CALIBRATE	INSTALL	REPLACE	REPAIR	OVERHAUL	REBUILD	Tools and equipment	Remarks
0305	Turbocharger								O	H	H			
0306	Tanks, Lines, Fittings:													
	Cap, fuel tank								O					
	Tank, fuel			C					O	F				
	Float assembly, day tank								O					
	Lines								O					
	Tube, fuel								O					
0308	Governor:													
	Governor and actuator	C			F				O	H	H			
0309	Fuel, Filters:													
	Filter, fuel			C					O					
0311	Engine Starting Aids													
	Primer, fuel			O										
	Lines, primer								O					
0312	Throttle Controls													
	Control, throttle								O					
04	EXHAUST SYSTEM													
0401	Muffler and Pipes:													
	Muffler and pipes								O					
05	COOLING SYSTEM													
0501	Radiator:													
	Radiator			C					O	F				
	Cap, radiator								O					
	Grill, radiator								O	F				
	Shutter assembly								O	F				
	Thermostat, shutter		O						O					
0503	Water Manifolds, Headers, Thermo- stats, and Housing Gaskets:													
	Manifold, water								O					
	Thermostat		O						O					
	Hose pipes								O					
0504	Water Pump:													
	Pump assembly, water			C					O	F				
0505	Fan Assembly:													
	Fan assembly								O					
	Belts, drive				C				O					
	Fan guard								O					
06	ELECTRICAL EQUIPMENT													
0601	Generator:													
	Generator, battery charging		O						O	F	H			
	Leads, electrical								O					
0602	Generator Regulator:													
	Regulator		O		F				O					
0603	Starting Motor:													
	Starter		O	O					O	F	H			
	Switch, solenoid								O					
0606	Engine Safety Controls:													
	Governor, overspeed								O	F				
	Switches, engine shutdown								O					
0607	Instrument or Engine Control Panel:													
	Ammeter								O					
	Gage, temperature, water, oil								O					
	Light, panel								O					

Section II. MAINTENANCE ASSIGNMENT

GROUP NUMBER	Component assembly nomenclature	Maintenance functions										Note reference		
		A	B	C	D	E	F	G	H	I	J	K	L	M
		INSPECT	TEST	SERVICE	ADJUST	ALIGN	CALIBRATE	INSTALL	REPLACE	REPAIR	OVERHAUL	REBUILD	Tools and equipment	Remarks
0608	Lamp								C					
	Switch, toggle								O					
	Wiring harness													
0612	Miscellaneous Items:													
	Receptacle, Battery, Charging								O					
0615	Batteries, storage:		O	C										
	Battery, storage.....													
15	Radio Interference Suppression:													
	Strap, ground								O					
1501	FRAME													
	Frame Assembly:													
	Frame assembly								H	F				
	Stud, ground.....								O					
	Eye, lifting.....								F					
18	BODY, CAB, HOOD AND HULL													
1801	Body, Cab, Hood and Hull													
	Assemblies:													
	Doors and hood								O					
	Panels.....								O					
	Housing								F					
1808	Boxes:													
	Box, Tool								O					
22	MISCELLANEOUS BODY, CHAS													
	SIS OR HULL AND ACCES													
	SORY ITEMS													
2202	Accessory Items:													
	Hose, auxiliary								O					
2207	Winterization:													
	Heater, battery box.....								O					
	Thermostat, battery box								O					
2210	Data Plates:													
	Plates, data.....								F					
	Plates, instruction								O					
40	ELECTRIC GENERATORS													
4000	Generator Assembly:	C	F	C					F	F	H			
	Generator assembly.....													
4001	Rotor Assemblies:		H						H	H	D			
	Rotor, generator.....													
4002	Stator Assemblies:		H						H	H	D			
	Stator, generator													
4003	Brushes:								H	H	D			
4004	Ventilating System:								O					
	Fan, ventilating.....													
	Screens			O					F					
4005	Frame Support and Housing:													
	Bearing								H					
4007	Drive Components:													
	Disc, coupling								F					
4009	Control Panels, Housing, Cubicles:													
	Converter								F					
	Lights.....								O					
	Lamp.....								F					
	Panel, control.....								F					

GROUP NUMBER	Component assembly nomenclature	Maintenance functions										Note reference		
		A	B	C	D	E	F	G	H	I	J	K	L	M
		INSPECT	TEST	SERVICE	ADJUST	ALIGN	CALIBRATE	INSTALL	REPLACE	REPAIR	OVERHAUL	REBUILD	Tools and equipment	Remarks
4011	Meters..... Receptacle..... Wiring harness..... Circuit Breakers: Circuit breaker assembly..... Fuse holder..... Fuse.....								O O F	O				
4012	Switches: Switch, rotary..... Switch, toggle.....								O O					
4013	Regulator, Voltage: Regulator, voltage..... Element.....				F				F F					
4014	Resistors: Resistor, variable..... Rheostat, voltage..... Resistor, fixed.....		O O F		O O				O O F					
4015	Relay or Assembly: Relay, assembly..... Relay, heater.....		F F						F F					
4017	Transformers: Transformers.....		F						F					
4018	Terminal Blocks: Terminal board assembly..... Links, shorting..... Board assembly reconnect.....								F F F					
4019	Radio Interference Suppression: Capacitors..... Leads, electrical.....		O						O O					
4023	Static Exciter Components: Rectifier, surge..... Insulator, assembly..... Transformer assembly.....								F F F	F				
47	GAGES													
4720	Gages: Gage, float, fuel.....								O					
76	FIRE FIGHTING EQUIPMENT													
7603	Fire Extinguisher: Extinguisher, Fire.....								C					

Section III. SPECIAL TOOL AND SPECIAL TEST EQUIPMENT REQUIREMENTS

Reference code	Maintenance level	Nomenclature	Tool number
		No special tools or equipment are required to perform maintenance on the generator set.	

Section IV. REMARKS

Reference Code	Remarks
	No special tools or test equipment are required to perform maintenance functions on the generator set.

INDEX

	Paragraph	Page
Adjusting valve clearance	3-22	3-18
Air cleaner service	3-8	3-6
Ammeter		
AC	3-66	3-60
Battery charging	3-63	3-55
Ammeter-voltmeter selector switch	3-70	3-60
Batteries.....	3-62	3-56
Battery charging ammeter.....	3-63	3-58
Belt, generator	3-12	3-7
Belt, water pump	3-12	3-7
Belts, fan.....	3-11	3-7
Brushes, main generator	3-82	3-43
Checking fuel system	3-41	3-36
Controls		
KVAR Adjust.....	3-76	3-61
KW Adjust.....	3-76	3-61
Controls and instruments.....	2-10	2-6
Conversion of equipment	2-6	2-4
Cooling system	3-42	3-42
Day tank float assembly	3-37	3-36
Demolition.....	4-5	4-2
Description.....	1-3	1-1
Difference in models	1-5	1-6
Dismantling for movement	2-7	2-5
Engine control switch	3-66	3-58
Electric fuel pump	3-35	3-34
Electric governor hydraulic actuator	3-39	3-36
Electric governor control unit.....	3-78	3-61
Engine shutdown switches.....	3-60	3-57
Engine valves	3-22	3-18
Equipment conversion.....	3-6	2-4
Engine priming instructions	3-23	2-18
Exhaust manifold	3-54	3-52
Exhaust pipe	3-55	3-53
Fan and belt guards	3-49	3-47
Fan belts.....	3-11	3-7
Remove.....	3-50	3-47
Service	3-11	3-7
Fan hub.....	3-51	3-45
Fault indicator panel.....	3-74	3-40
Filters, fuel		
Removal	3-30	3-25
Servicing	3-10	3-7
Fire extinguisher	3-21	3-18
Float assembly, day tank		
Frequency control rheostat.....	3-71	3-41
Frequency switch	3-77	3-61

	Paragraph	Page
Fuel injection nozzle holder assembly	3-33	3-31
Fuel injection pump.....	3-32	3-25
Fuel system	3-29	3-24
Fuel strainers and filter		
Removal	3-30	3-25
Servicing	3-10	3-7
Fuel system check	3-41	3-36
Fuel lines	3-38	336
Fuel tank		
Removal	3-36	3-34
Service	3-9	3-6
Fuel transfer pump.....	3-34	3-34
Fuses	3-13	3-7
Gages	3-65	3-58
Generator.....	3-57	3-54
Generator belt	3-12	3-7
Generator regulator.....	3-58	3-56
Generator wiring.....	3-57	3-60
Governor, injection pump.....	3-40	3-36
Governor, overspeed	3-59	3-57
Grill, radiator	3-43	3-42
Ground stud	3-79	3-62
Guards, fan and belt.....	3-49	3-47
Heaters	3-83	3-64
Housing.....	3-80	3-62
Hydraulic actuator	3-39	3-36
Identification	1-4	1-2
Injection nozzle	3-33	3-31
Injection pump	3-32	3-25
Injector pump governor	3-40	3-36
Inspecting equipment	2-3	2-1
Inspection during storage	4-4	4-2
Installation.....	2-5	2-2
Installation of separately packed components	2-4	2-1
Instruments	2-10	2-6
Intake manifold	3-53	3-50
KVAR Adjust Control.....	3-75	3-61
KW Adjust Control.....	3-76	3-61
Lamps	3-13	3-7
Limited storage	4-4	4-1
Lubrication	3-3	3-1
Lubrication system	3-24	3-21
Main generator	3-81	3-63
Main generator brushes.....	3-62	3-63
Mechanical governor, injector pump	3-40	3-36
Model difference	1-5	1-6
Moisture collector	3-14	3-8
Nozzle holder assembly	3-33	3-31
Oil cooler	3-28	3-22
Oil filter relief valve.....	3-26	3-22
Oil filters	3-25	3-21
Oil pressure regulating valve.....	3-27	3-22
Operation under unusual conditions		
Cold.....	2-15	2-16

	Paragraph	Page
Dusty or sandy	2-17	2-17
Heat	2-16	2-17
High altitudes.....	2-20	2-18
Rainy or humid area	2-18	2-17
Salt water area	2-19	2-17
Organizational maintenance repair parts	3-2	3-1
Overspeed governor	3-59	3-57
Parallel operation	2-14	2-11
Preventive maintenance	3-5	3-5
Prime to start	2-23	2-18
Pump		
Electric fuel.....	3-3	3-34
Fuel transfer	3-34	3-34
Pump, fuel injection	3-32	3-25
Radiator	3-45	3-43
Radiator grill.....	3-43	3-42
Radiator shutter	3-44	3-42
Radio interference suppression	3-18	3-16
Record and report forms	1-2	1-1
Regulator, generator	3-58	3-56
Reinstallation after movement	2-8	2--5
Rheostat		
Frequency control.....	3-71	3-60
Voltage control.....	3-7	3-60
Scope	1-1	1-1
Servicing equipment	2-3	2-1
Setting up equipment	2-5	2-2
Shipment	4-1	4-1
Shutter control.....	3-44	3-42
Shutter, radiator	3-44	3-42
Single unit operation	2-14	2-11
Slave receptacles	3-61	3-57
Starter solenoid switch	3-56	3-54
Starting	2-12	2-11
Starting motor	3-56	3-54
Stopping.....	2-13	2-11
Strainer, fuel		
Removal	3-30	3-25
Servicing	3-10	3-7
Suppression components, radio interference	3-18	3-16
Switches	3-73	3-60
Switches, shutdown	3-60	3-57
Switch, solenoid	3-56	3-54
Tabulated data	1-4	1-2
Testing radio suppression component	3-21	3-17
Thermostats	3-47	3-43
Time totaling meter	3-64	3-58
Tools and equipment	3-1	3-1
Transfer pump	3-34	3-34
Troubleshooting	3-15	3-12
Turbocharger	3-52	3-49
Unloading equipment	2-1	2-1
Unpacking equipment.....	2-2	2-1
V-Belts	3-11	3-7
Valve clearance	3-23	3-18

	Paragraph	Page
Valve mechanism	3-22	3-18
Vent fuel system	3-31	3-25
Voltage control rheostat	3-72	3-60
Voltmeter	3-69	3-60
Water outlet manifold	3-46	3-43
Water pump belt	3-12	3-7
Winterization equipment	2-22	2-18

By Order of the Secretary of the Army:

HAROLD K. JOHNSON,
General, United States Army,
Chief of Staff.

Official:

KENNETH G. WICKHAM,
Major General, United States Army,
The Adjutant General.

Distribution:

Active Army:

USASA (2)	Gen Dep (10)
ACSI (1)	Engr Dep (10)
DCSLOG (1)	Army Dep (2) except
CNGB (1)	TOAD (3)
TSG (1)	EAMTMTS (2)
CofEngrs (3)	WAMTMTS (2)
ACSC-E (1)	MOTBA (1)
Dir of Trans (1)	MOTBY (1)
CofSptS (1)	MOTKI (1)
USAMB (1)	MOTSU (1)
USA Arty Bd (2)	Div Engr (2)
USA Armor Bd (2)	Engr Dist (2)
USAIB (2)	Engr Cen (5)
USARADB (2)	AMS (3)
USAAESWBD (2)	MAAG (1)
USAAVNTB (2)	JBUSMC (1)
USCONARC (3)	USARMA (1)
OS Maj Comd (5) except	USARMIS (1)
USARJ (1)	Engr FLDMS (2)
USASETAF (2)	Ft Knox FLDMS (10)
USAMC (1)	USACOMZEUR (2)
USACDCEC (10)	Fid Comd, DASA (8)
USAMECOM (46)	USA Mbl Equip R&D Cen (3)
MDW (1)	USAREUR Engr Proc Cen (2)
Armies (2)	USAREUR Engr Sup Con Agcy (10)
Corps (2)	Units org under fol TOE:
USAC (1)	5-48 (2)
Div (2)	5-237 (5)
Engr Bde (1)	5-262 (5)
USMA (2)	5-287 (1)
Svc Colleges (2)	5-278 (5)
Br Svc Sch (2)	5-279 (2)

NG: None.

USAR: Same as Active Army except allowance is (1) copy for each unit.

For explanation of abbreviations used, see AR 320-50.

- A1 THERMAL WGT CONVERTER
 - A2 FREQUENCY TRANSDUCER
 - A3 FLASHER PC BOARD ASSY
 - A4 CONTROL BOX PC BOARD ASSY
 - A5 RELAY BOX PC BOARD ASSY
 - A6 RESISTOR PC BOARD ASSY
 - A7 GOV PARALLELING CONT PC BOARD ASSY
 - B1 MOTOR OPERATOR SEE CI
 - B2,B3 FAN AND PUMP MOT SEE HR
 - B4 STARTER MOTOR SEE STR
 - BT1 THRU BT4 BATTERY/4 UNITS MS35000-4
 - C8 CAPACITOR SEE A6
 - CAM SW CAM SWITCH SEE CI
 - CB1 AND CB2 HTR CKT BKR SEE HCB MS-2507
 - CCCT CROSS CURRENT COMPENSATING XMFR
 - CHG GEN CHARGING GENERATOR
 - CI CIRCUIT INTERRUPTER
 - CR1 AND CR2 SEE A4 MIL-S-19500 IN 1695
 - CR3 THRU CR5 SEE A5 MIL-S-19500 IN 1695
 - CR6 SEE A5 MIL-S-19500 MR1033A
 - CT1 THRU CT3 CONTROL TRANSFORMER
 - DCPC DC CONT POWER CKT BREAKER
 - DS1 THRU DS5 PANEL LT ASSY
 - DS6,DS7 LT ASSY PRESS TO TEST
 - DS8,DS9 LT ASSY PRESS TO TEST SEE HCB
 - F1 FAULT INDICATOR 13205E4770
 - F2 FUEL PUMP / 4 UNITS MS51321-2
 - F3R FLASHER SEE A3
 - F 15A FUSE MS90079-7
 - GA HYDRAULIC ACTUATOR 13214E7672
 - GPU GOVERNOR CONTROL UNIT 13214E7670
 - GEN GENERATOR ASSY 13214E7163
- GENERATOR
- CVT1 THRU CVT3 CUR V XMFR 13214E7155
 - FD8 FIELD DIODE BOX 13214E8693
 - CR1,CR3,CR5 MIL-S-19500 IN1190A
 - CR2,CR4,CR6 MIL-S-19500 IN1190AR
 - LR LINEAR REACTOR 13214E7156
 - R15 MIL-R-26 RW35V250
 - R16 MIL-R-26 RW35V100
 - SP2 13214E7159
 - T4 TRANSFORMER 13205E4822
- HCB HEATER CONTROL BOX 2/UNITS 1321E3155
 - HR ENGINE HEATER 1321E7385
 - K1 LOCK-ON RELAY SEE A-4 1321E6944
 - K2 OVERVOLTAGE RELAY
 - K3 CRANK LIMIT RELAY
 - K4 GOV PAR CONT RELAY SEE-A7 1321E6944
 - K5 FIELD FLASHING RELAY SEE-A5 1321E6944
 - K6 RMTE SENSING RELAY SEE-A5 1321E6944
 - K7 PARALLEL V CONT REL 1321E6944
 - K8 FUEL LEVEL RELAY SEE-A5 1321E6944
 - K9 CIRCUIT BREAKER CONTROL
 - K11 UNDERVOLTAGE RELAY
 - K12 STARTER RELAY SEE STR
 - K13 SHORT CIRCUIT RELAY
 - K14 OVERLOAD RELAY
 - K15 REVERSE POWER RELAY
 - K16 CI RELAY
 - K21A RMTE SENSING REL ACTR (GFE)
 - K21 AND K22 RMTE SENSING REL (GFE)
 - L1 AND L2 FUEL SHUTDOWN SOL 1321E7485
 - L3 ETHER STARTING AID SOL 1321E7480
 - L4, L5 FUEL SOL. SEE HR
 - LMU LOAD MEASUREMENT UNIT 13214E7671
 - LP LOAD CONNECTION PANEL 1321E7604
 - M1 PRESSURE INDICATOR
 - M2 TEMPERATURE INDICATOR
 - M3 LIQUID LEVEL INDICATOR
 - M4 BAT. CHARGING DC AMMETER
 - M5 RUNNING-TIME METER
 - M6 FREQUENCY METER
 - M7 WATTMETER
 - M8 AC AMMETER
 - M9 AC VOLTMETER
 - MT1 OIL PRESSURE SENDING UNIT

- MT2 WATER PUMP SENDING UNIT
 - MT3 FUEL GAUGE TRANSMITTER
 - PR PARALLELING RECEPT/UNITS
 - PVCS PARALLELING V CONT SYS
 - R1,R2 FREQ/VOLT ADJUST
 - R3,R6 SEE A5,A6 MIL-R-26 RW66V152
 - R4,R7 SEE A5 MIL-R-26 RW66V242
 - R5,R6 SEE A5 MIL-R-26 RW66V512
 - R8,R9 SEE A6 MIL-R-18546 RE7063000
 - R11 THRU R13 MIL-R-26 RE7697R50
 - C4 MIL-C-12889 CAS6KF104
 - DI/4 UNITS MIL-S-19500 IN1908
 - D3 MIL-S-19500 IN4723
 - D5/4 UNITS MIL-S-19500 IN2107
 - D6 MIL-S-19500 IN2964
 - D7/2 UNITS "DOUBLER" 13214E7162
 - LI REACTOR 13205E4836
 - Q1 MIL-S-19500 2N1132
 - Q2 MIL-S-19500 2N2646
 - R1 MIL-R-26 RW33V501
 - R3 MIL-R-26 RW59V201
 - R4 MIL-R-26 RW59V392
 - R5,R12 MIL-R-26 RW59V502
 - R6 MIL-R-26 RW59V100
 - R7 MIL-R-26 RW59V200
 - R10,R17 -R-26 RW69V272
 - R11 MIL-R-26 RW33V252
 - R16 MIL-R-26 RW33V250
 - R15 MIL-R-26 RW33V100
 - R18 MIL-R-26 RW33V102
 - SCR MIL-S-19500 2N1774A
 - SP1 13214E8718
 - T1 13214E8706
 - T2 13214E8708
 - T3 13205E4809
 - Z1 MIL-S-19500 IN1825A
 - Z2 MIL-S-19500 IN1826
- VR2 VOLT REG ASSY-DC 13214E7650
- NOTE: NUMBERS SHOWN WITH >> SEE WIRING DIAGRAM JACK PART NUMBERS
- R14 AND R15 KW/KVAR ADJUST
 - R16 FLASHER - SEE A3
 - RCN RECONNECTION PANEL
 - RSU RMTE SENSING UNIT (GFE)
 - S1 ETHER START SWITCH
 - S2 START-RUN-STOP SWITCH
 - S3 CKT BKR SWITCH
 - S4 PANEL LIGHT SWITCH
 - S5 RMTE SENSING UNIT SW
 - S6 PARALLEL VOLT CONT SW
 - S7 PROTECTION BYPASS SW
 - S8 VA SELECTOR SW
 - S9 50-60 CYCLE SW
 - S10 AND S11 HEATER SW SEE HCB
 - S12 FUEL LEVEL SWITCH 13214E7348
 - S13 WINTER THERMO SW 13214E7804
 - S14 AND S15 OVERHEAT SWITCH SEE HR
 - S16 AND S17 FLAME SWITCH SEE HR
 - S18 OIL PRESSURE SW 13214E7448
 - S19 WATER TEMP SW 13214E7443
 - S20 SPEED SW 13214E7435
 - S1 SHUNT 13214E7668
 - SR SLAVE RECP MS 75058-1
 - STR ENGINE STARTER 13214E7545
 - VRI VOLTAGE REG ASSY 13214E7159
- VOLTAGE REGULATOR
- C1,C3,C5 MIL-C-18312 CH04A1NC405K
 - C2 MIL-C-25 CPO9A1KC474K3
 - C3 MIL-C-18312 CH04A1NC206K

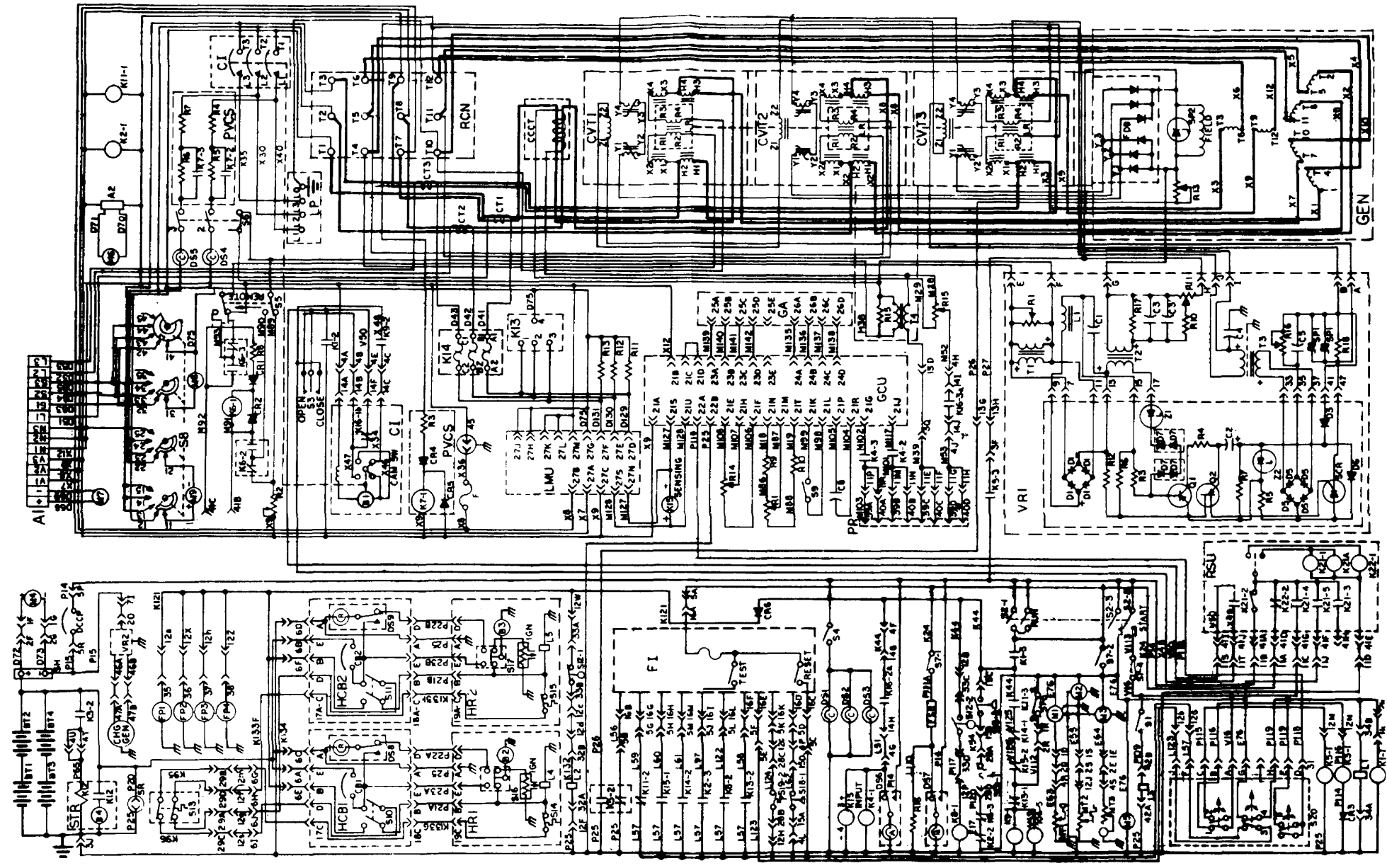



Figure 1-3. Wiring diagram

RECOMMENDED CHANGES TO EQUIPMENT TECHNICAL PUBLICATIONS

 <div style="border: 1px solid black; border-radius: 15px; padding: 5px; display: inline-block; margin-left: 20px;"> <p style="margin: 0;"><i>THEN...JOT DOWN THE DOPE ABOUT IT ON THIS FORM. CAREFULLY TEAR IT OUT, FOLD IT AND DROP IT IN THE MAIL.</i></p> </div>		SOMETHING WRONG WITH PUBLICATION		
		FROM: (PRINT YOUR UNIT'S COMPLETE ADDRESS)		
PUBLICATION NUMBER		DATE SENT		
PUBLICATION DATE		PUBLICATION TITLE		
BE EXACT PIN-POINT WHERE IT IS				
PAGE NO.	PARA- GRAPH	FIGURE NO.	TABLE NO.	<p style="text-align: center; font-weight: bold; margin-top: 0;">IN THIS SPACE, TELL WHAT IS WRONG AND WHAT SHOULD BE DONE ABOUT IT.</p>
PRINTED NAME, GRADE OR TITLE AND TELEPHONE NUMBER			SIGN HERE	

The Metric System and Equivalents

Linear Measure

1 centimeter = 10 millimeters = .39 inch
 1 decimeter = 10 centimeters = 3.94 inches
 1 meter = 10 decimeters = 39.37 inches
 1 dekameter = 10 meters = 32.8 feet
 1 hectometer = 10 dekameters = 328.08 feet
 1 kilometer = 10 hectometers = 3,280.8 feet

Weights

1 centigram = 10 milligrams = .15 grain
 1 decigram = 10 centigrams = 1.54 grains
 1 gram = 10 decigrams = .035 ounce
 1 decagram = 10 grams = .35 ounce
 1 hectogram = 10 decagrams = 3.52 ounces
 1 kilogram = 10 hectograms = 2.2 pounds
 1 quintal = 100 kilograms = 220.46 pounds
 1 metric ton = 10 quintals = 1.1 short tons

Liquid Measure

1 centiliter = 10 milliliters = .34 fl. ounce
 1 deciliter = 10 centiliters = 3.38 fl. ounces
 1 liter = 10 deciliters = 33.81 fl. ounces
 1 dekaliter = 10 liters = 2.64 gallons
 1 hectoliter = 10 dekaliters = 26.42 gallons
 1 kiloliter = 10 hectoliters = 264.18 gallons

Square Measure

1 sq. centimeter = 100 sq. millimeters = .155 sq. inch
 1 sq. decimeter = 100 sq. centimeters = 15.5 sq. inches
 1 sq. meter (centare) = 100 sq. decimeters = 10.76 sq. feet
 1 sq. dekameter (are) = 100 sq. meters = 1,076.4 sq. feet
 1 sq. hectometer (hectare) = 100 sq. dekameters = 2.47 acres
 1 sq. kilometer = 100 sq. hectometers = .386 sq. mile

Cubic Measure

1 cu. centimeter = 1000 cu. millimeters = .06 cu. inch
 1 cu. decimeter = 1000 cu. centimeters = 61.02 cu. inches
 1 cu. meter = 1000 cu. decimeters = 35.31 cu. feet

Approximate Conversion Factors

To change	To	Multiply by	To change	To	Multiply by
inches	centimeters	2.540	ounce-inches	Newton-meters	.007062
feet	meters	.305	centimeters	inches	.394
yards	meters	.914	meters	feet	3.280
miles	kilometers	1.609	meters	yards	1.094
square inches	square centimeters	6.451	kilometers	miles	.621
square feet	square meters	.093	square centimeters	square inches	.155
square yards	square meters	.836	square meters	square feet	10.764
square miles	square kilometers	2.590	square meters	square yards	1.196
acres	square hectometers	.405	square kilometers	square miles	.386
cubic feet	cubic meters	.028	square hectometers	acres	2.471
cubic yards	cubic meters	.765	cubic meters	cubic feet	35.315
fluid ounces	milliliters	29.573	cubic meters	cubic yards	1.308
pints	liters	.473	milliliters	fluid ounces	.034
quarts	liters	.946	liters	pints	2.113
gallons	liters	3.785	liters	quarts	1.057
ounces	grams	28.349	liters	gallons	.264
pounds	kilograms	.454	grams	ounces	.035
short tons	metric tons	.907	kilograms	pounds	2.205
pound-feet	Newton-meters	1.356	metric tons	short tons	1.102
pound-inches	Newton-meters	.11296			

Temperature (Exact)

°F	Fahrenheit temperature	5/9 (after subtracting 32)	Celsius temperature	°C
----	------------------------	----------------------------	---------------------	----

GENERATOR SET, DIESEL ENGINE: 200 KW-1968